

# NXR-800

## SERVICE MANUAL

### SUPPLEMENT E3 version

# KENWOOD

Kenwood Corporation

© 2009-10 PRINTED IN JAPAN  
B51-8895-00 (N) 84

This NXR-800 (E3) service manual contains a number of sections which differ from the service manual (B51-8854-00) for NXR-800 (E). For items other than those in this NXR-800 (E3) service manual, please refer to the service manual (B51-8854-00) for NXR-800 (E).

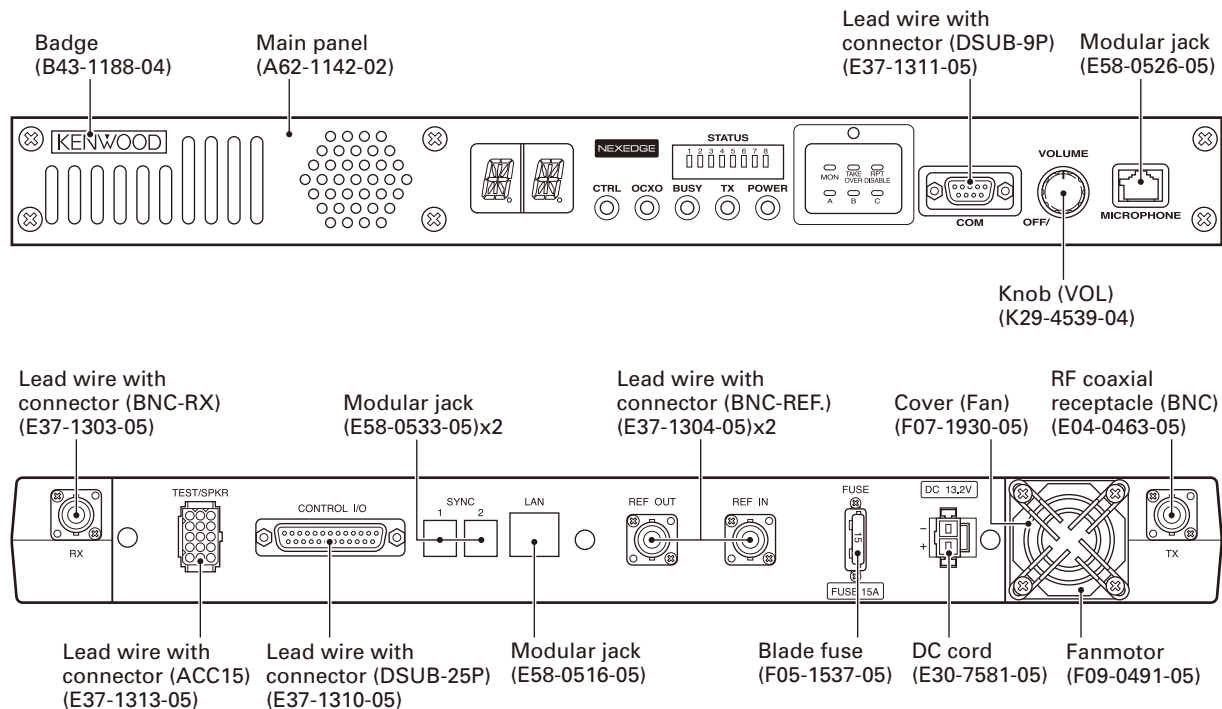

## CONTENTS

<b>GENERAL</b> .....	<b>2</b>	<b>PC BOARD</b>	
<b>SYSTEM SET-UP</b> .....	<b>3</b>	<b>FINAL UNIT (X45-3862-71)</b> .....	<b>40</b>
<b>CIRCUIT DESCRIPTION</b> .....	<b>4</b>	<b>RF UNIT (X55-3102-72)</b> .....	<b>44</b>
<b>PARTS LIST</b> .....	<b>6</b>	<b>TX UNIT (X56-3120-12)</b> .....	<b>48</b>
<b>EXPLODED VIEW</b> .....	<b>26</b>	<b>SCHEMATIC DIAGRAM</b> .....	<b>52</b>
<b>PACKING</b> .....	<b>28</b>	<b>SPECIFICATIONS</b> .....	<b>BACK COVER</b>
<b>ADJUSTMENT</b> .....	<b>29</b>		



# NXR-800

## Document Copyrights

Copyright 2009 by Kenwood Corporation. All rights reserved.

No part of this manual may be reproduced, translated, distributed, or transmitted in any form or by any means, electronic, mechanical, photocopying, recording, or otherwise, for any purpose without the prior written permission of Kenwood.

## Disclaimer

While every precaution has been taken in the preparation of this manual, Kenwood assumes no responsibility for errors or omissions. Neither is any liability assumed for damages resulting from the use of the information contained herein. Kenwood reserves the right to make changes to any products herein at any time for improvement purposes.

## Firmware Copyrights

The title to and ownership of copyrights for firmware embedded in Kenwood product memories are reserved for Kenwood Corporation. Any modifying, reverse engineering, copy, reproducing or disclosing on an Internet website of the firmware is strictly prohibited without prior written consent of Kenwood Corporation. Furthermore, any reselling, assigning or transferring of the firmware is also strictly prohibited without embedding the firmware in Kenwood product memories.

Transceivers containing AMBE+2™ Vocoder:

The AMBE+2™ voice coding technology is embedded in the firmware under the license of Digital Voice Systems, Inc.

# GENERAL

## INTRODUCTION

### SCOPE OF THIS MANUAL

This manual is intended for use by experienced technicians familiar with similar types of commercial grade communications equipment. It contains all required service information for the equipment and is current as of the publication date. Changes which may occur after publication are covered by either Service Bulletins or Manual Revisions. These are issued as required.

### ORDERING REPLACEMENT PARTS

When ordering replacement parts or equipment information, the full part identification number should be included. This applies to all parts : components, kits, or chassis. If the part number is not known, include the chassis or kit number of which it is a part, and a sufficient description of the required component for proper identification.

## PERSONAL SAFETY

The following precautions are recommended for personal safety :

- DONOT transmit if someone is within two feet (0.6 meter) of the antenna.
- DONOT transmit until all RF connectors are secure and any open connectors are properly terminated.
- SHUT OFF this equipment when near electrical blasting caps or while in an explosive atmosphere.
- All equipment should be properly grounded before powerup for safe operation.
- This equipment should be serviced by only qualified technicians.

## SERVICE

This transceiver is designed for easy servicing. Refer to the schematic diagrams, printed circuit board views, and alignment procedures contained within.

### Service Manual List

Title	Parts number	Remarks	Market code
NXR-800	B51-8854-00	First edition	E
NXR-800	B51-8895-00	Supplement	E3

## SYSTEM SET-UP

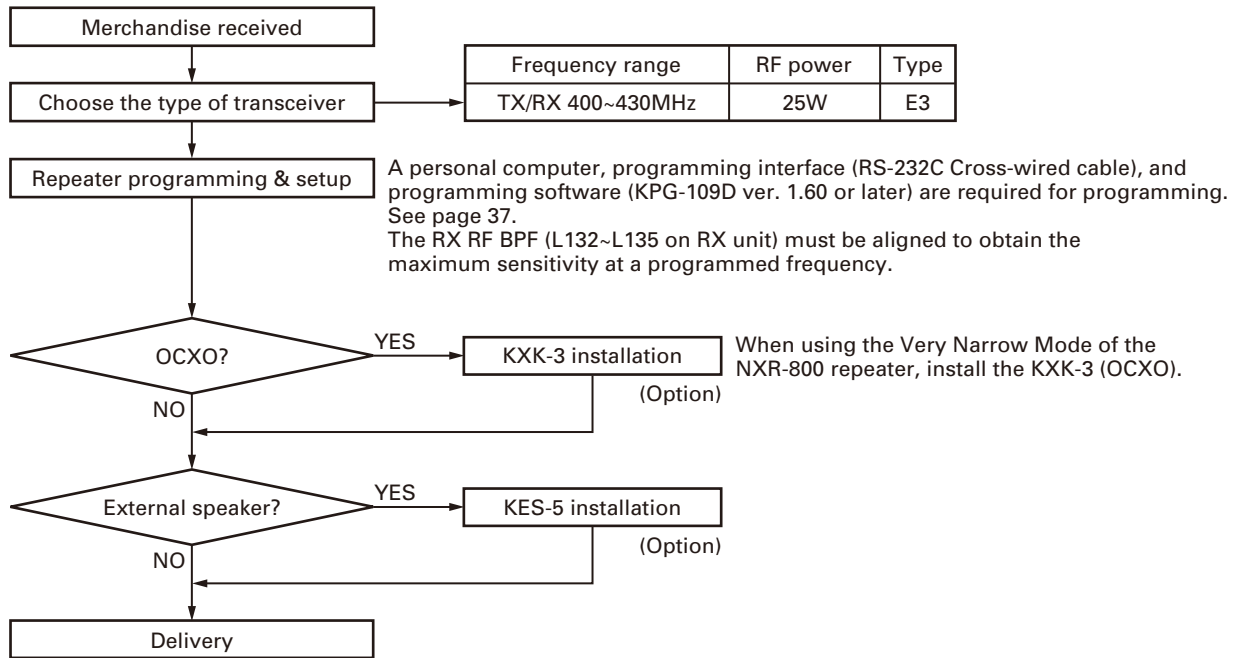

### ■ Cross-wired cable

There are a few types of null modem cable available in the market. Make sure to use one of the following null modem cables that meets the following specifications.

Cable Specification: Null modem cable with full handshaking (cross-wired) or InterLink cable that is usually used to transfer files between PCs.

Connector Specification (both cable ends): DB-9 female

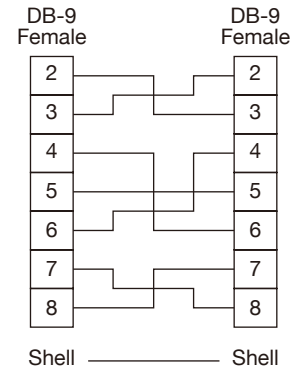
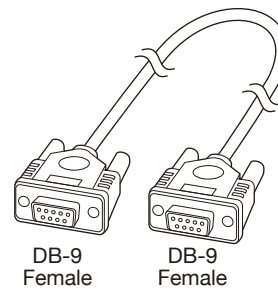

## CIRCUIT DESCRIPTION

### 1. Transmitter main PLL circuit

The transmitter main PLL circuit consists of the VCO (Q102 and Q103), PLL IC (IC101), IC102, Q104 and Q106 and produces the transmitter frequency signal.

The VCO Q102 produces transmitter frequencies from 400.000MHz to 414.995MHz.

The VCO Q103 produces transmitter frequencies from 415.000MHz to 430.000MHz.

The signal produced by the VCO (Q102 or Q103) is fed to the buffer amplifier and is amplified by Q106. The higher harmonic wave is attenuated by LPF and returns to the PLL IC (IC101).

IC101 divides the VCO oscillating frequency signal and transmitter PLL reference signal (4.5MHz), and compares the phase with the 100kHz comparison frequency.

The phase difference signal produced by the comparing phase is converted to a DC voltage by a lag-lead type loop filter.

The DC signal is applied to varicaps D101, D102, D107, and D108 to lock the VCO oscillator frequency with the desired oscillator frequency.

At the same time, the DC signal passes through the IC102 operational amplifier for monitoring the transmitter main PLL lock voltage.

The output from the VCO passes through the buffer amplifier Q104 and is supplied to the drive circuit.

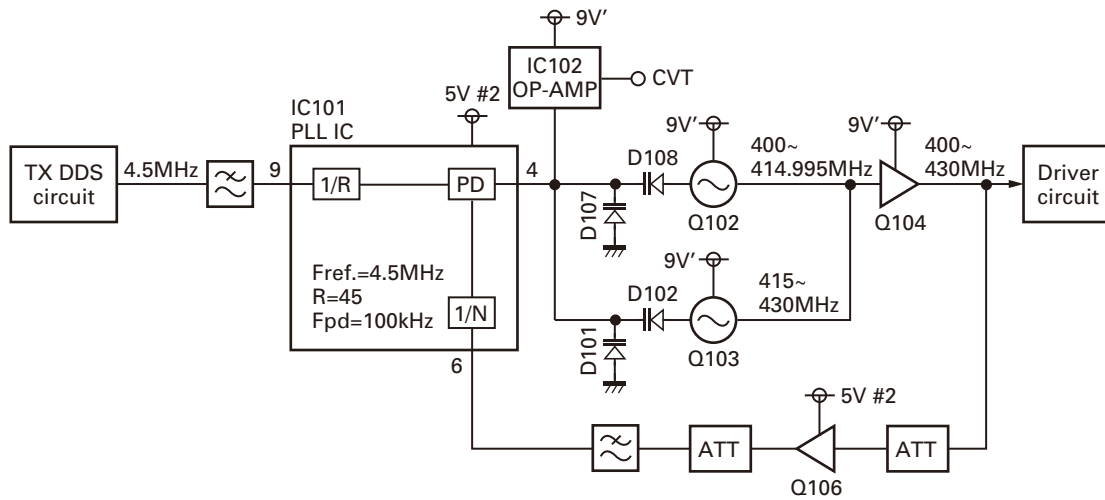

**Fig. 1 Transmitter main PLL circuit**

## CIRCUIT DESCRIPTION

### 2. Receiver PLL circuits

The receiver unit (X55-310) has the 1st-PLL circuit for controlling the VCO that generates the hetero signal to the first local oscillator, and the 2nd-PLL circuit for controlling the VCO that generates the hetero signal to the second local oscillator.

The 1st-PLL circuit consists of the VCO (Q7 and Q8), the Buffer amplifier (Q17), the RF amplifiers (Q16 and Q3), the PLL-IC (IC5), the Active loop filters (Q2 and Q4) and the Band switches (Q14, Q10, Q11 and Q59). The signal in the 350.05~365.05MHz band generated by VCO Q7 and the 365.05~380.05MHz band generated by VCO Q8 is input to IC5 (pin5) via Q17 and Q16 as the Fin signal. The 6MHz reference signal generated by the DDS-IC (IC7) is input to IC5 (pin8) via Q3. Two signals, Fin and REFin, are phase-compared by each frequency divider. The VCO output with the frequency synchronized is input to the 1st-Mixer as the first local oscillator Lower hetero signal approximately +17dBm via Q17, Q23, and Q18. The control voltage is input to IC30 (ADC) pin16 via IC6.

Meanwhile, the 2nd-PLL circuit consists of the VCO (Q24), the Buffer amplifier (Q33), the RF amplifier (Q38, Q22), and the PLL-IC (IC11). The 99.0MHz signal generated by Q24 is input to IC11 (pin5) as the Fin signal via Q38. The 19.2MHz Internal reference clock distributed by the transmitter unit (X56-312) is input as the REFin signal to IC11 (pin8) via Q22. Two signals, Fin and REFin, are phase-compared by each frequency divider as the comparison frequency of 200kHz. The VCO output with the frequency synchronized is input to IC9 (prescaler IC) pin2 via Q33 and Q21. The 49.5MHz signal is frequency-divided into halves by IC9 and is excited by Q53 and distributed. One is input to IC12 (pin1) via Buffer amplifier\_Q35. The other is input to IC13 (pin4) via Buffer amplifier\_Q36. Both are input as approximately -16dBm for the second local oscillator Lower hetero signal. The control voltage at this point is input to IC30 (ADC) pin10 via IC33.

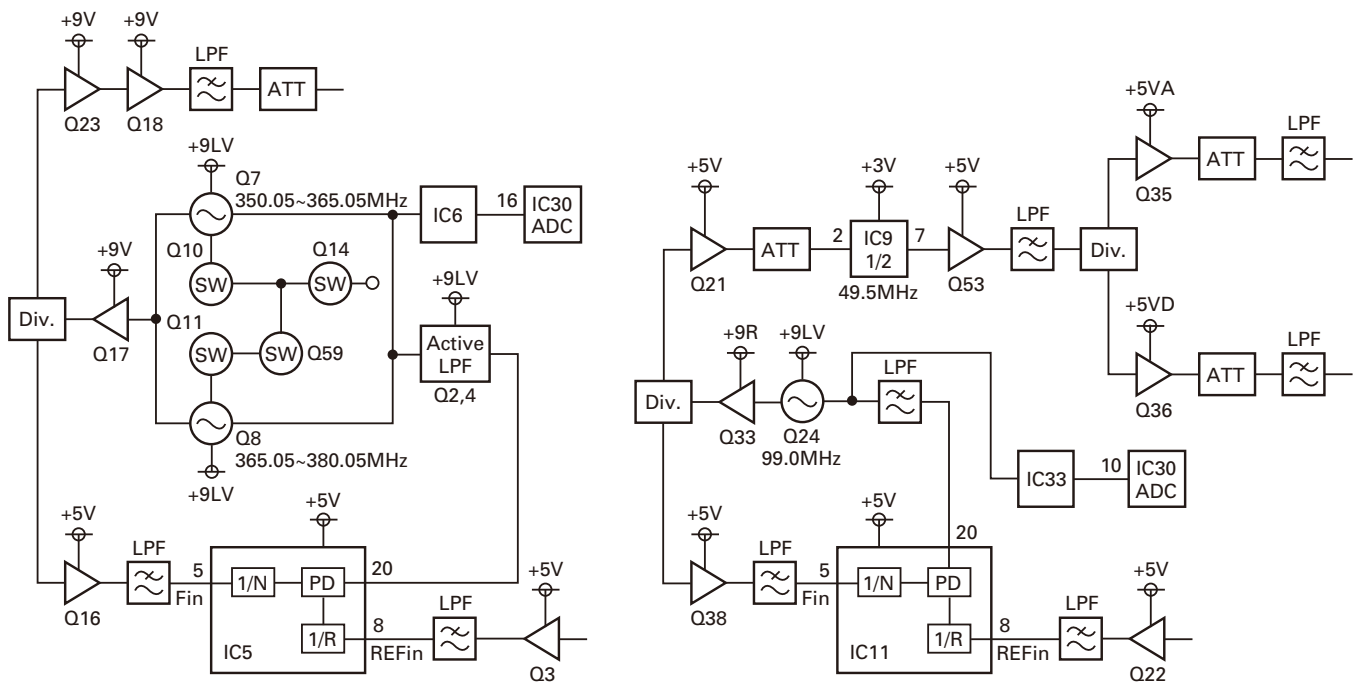

Fig. 2 Receiver PLL circuits

## PARTS LIST

### CAPACITORS

$\frac{C}{1} \frac{C}{2} \frac{45}{3} \frac{TH}{4} \frac{1H}{5} \frac{220}{6} \frac{J}{6}$

- 1 = Type ... ceramic, electrolytic, etc.
- 2 = Shape ... round, square, etc.
- 3 = Temp. coefficient
- 4 = Voltage rating
- 5 = Value
- 6 = Tolerance

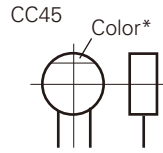

#### • Capacitor value

- 010 = 1pF
- 100 = 10pF
- 101 = 100pF
- 102 = 1000pF = 0.001μF
- 103 = 0.01μF

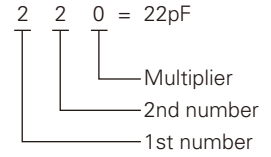

#### • Temperature coefficient

1st Word	C	L	P	R	S	T	U
Color*	Black	Red	Orange	Yellow	Green	Blue	Violet
ppm/°C	0	-80	-150	-220	-330	-470	-750

2nd Word	G	H	J	K	L
ppm/°C	±30	±60	±120	±250	±500

Example : CC45TH = -470±60ppm/°C

#### • Tolerance (More than 10pF)

Code	C	D	G	J	K	M	X	Z	P	No code
(%)	±0.25	±0.5	±2	±5	±10	±20	+40 -20	+80 -20	+100 -0	More than 10μF : -10~+50 Less than 4.7μF : -10~+75

#### (Less than 10pF)

Code	B	C	D	F	G
(pF)	±0.1	±0.25	±0.5	±1	±2

#### • Voltage rating

2nd word \ 1st word	A	B	C	D	E	F	G	H	J	K	V
0	1.0	1.25	1.6	2.0	2.5	3.15	4.0	5.0	6.3	8.0	-
1	10	12.5	16	20	25	31.5	40	50	63	80	35
2	100	125	160	200	250	315	400	500	630	800	-
3	1000	1250	1600	2000	2500	2150	4000	5000	6300	8000	-

#### • Chip capacitors

- (EX)  $\frac{C}{1} \frac{C}{2} \frac{73}{3} \frac{F}{4} \frac{SL}{5} \frac{1H}{6} \frac{000}{7} \frac{J}{7}$  → Refer to the table above.
- (Chip) (CH, RH, UJ, SL)
- 1 = Type
  - 2 = Shape
  - 3 = Dimension
  - 4 = Temp. coefficient
  - 5 = Voltage rating
  - 6 = Value
  - 7 = Tolerance
- (EX)  $\frac{C}{1} \frac{K}{2} \frac{73}{3} \frac{F}{4} \frac{F}{5} \frac{1H}{6} \frac{000}{7} \frac{Z}{7}$
- (Chip) (B, F)

#### • Dimension

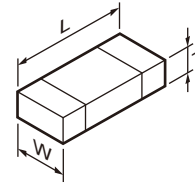

#### Chip capacitor

Code	L	W	T
Empty	5.6±0.5	5.0±0.5	Less than 2.0
A	4.5±0.5	3.2±0.4	Less than 2.0
B	4.5±0.5	2.0±0.3	Less than 2.0
C	4.5±0.5	1.25±0.2	Less than 1.25
D	3.2±0.4	2.5±0.3	Less than 1.5
E	3.2±0.2	1.6±0.2	Less than 1.25
F	2.0±0.3	1.25±0.2	Less than 1.25
G	1.6±0.2	0.8±0.2	Less than 1.0
H	1.0±0.05	0.5±0.05	0.5±0.05

#### Chip resistor

Code	L	W	T
E	3.2±0.2	1.6±0.2	1.0
F	2.0±0.3	1.25±0.2	1.0
G	1.6±0.2	0.8±0.2	0.5±0.1
H	1.0±0.05	0.5±0.05	0.35±0.05

#### • Rating wattage

Code	Wattage	Code	Wattage	Code	Wattage
1J	1/16W	2C	1/6W	3A	1W
2A	1/10W	2E	1/4W	3D	2W
2B	1/8W	2H	1/2W		

### RESISTORS

#### • Chip resistor (Carbon)

- (EX)  $\frac{R}{1} \frac{D}{2} \frac{73}{3} \frac{E}{4} \frac{B}{5} \frac{2B}{6} \frac{000}{7} \frac{J}{7}$
- (Chip) (B, F)

#### • Carbon resistor (Normal type)

- (EX)  $\frac{R}{1} \frac{D}{2} \frac{14}{3} \frac{B}{4} \frac{B}{5} \frac{2C}{6} \frac{000}{7} \frac{J}{7}$

- 1 = Type
- 2 = Shape
- 3 = Dimension
- 4 = Temp. coefficient
- 5 = Rating wattage
- 6 = Value
- 7 = Tolerance

## PARTS LIST

\* New Parts. Δ indicates safety critical components.

Parts without **Parts No.** are not supplied.

Les articles non mentionnés dans le **Parts No.** ne sont pas fournis.

Teile ohne **Parts No.** werden nicht geliefert.

L : Scandinavia

Y : PX (Far East, Hawaii)

C : China

K : USA

T : England

X : Australia

P : Canada

E : Europe

M : Other Areas

### NXR-800

### FINAL UNIT (X45-3862-71)

Ref. No.	Address	New parts	Parts No.	Description	Destination
<b>NXR-800</b>					
1	3A		A62-1142-02	MAIN PANEL	
3	1E		B10-2781-04	FRONT GLASS      ACCESSORY	
4	3A		B11-1841-04	FILTER (PF)	
5	3A		B11-1842-04	FILTER (17SEG)	
6	3		B11-1843-04	FILTER (LED)	
7	3A		B11-1844-04	FILTER (STATUS)	
8	3A		B42-7296-04	STICKER (NEXEDGE)	
9	3A		B43-1188-04	BADGE	
10	1F		B62-2114-00	INSTRUCTION MANUAL	
12	2B		E04-0463-05	RF COAXIAL RECEPTACLE (BNC)	
13	1F		E30-3344-25	DC CORD      ACCESSORY	
14	1B		E30-7581-05	DC CORD	
15	2C		E30-7582-05	TRUNK CABLE	
16	1B,2C		E30-7583-05	TRUNK CABLE	
17	1B,1C		E37-1295-05	FLAT CABLE (36P)	
18	1B		E37-1299-05	LEAD WIRE WITH TERMINAL (FUSE-DC+)	
19	1B		E37-1300-05	LEAD WIRE WITH TERMINAL (FUSE-DC-)	
20	1B		E37-1301-05	LEAD WIRE WITH TERMINAL (DCPA+)	
21	1B		E37-1302-05	LEAD WIRE WITH TERMINAL (DCPA-)	
22	2C		E37-1303-05	LEAD WIRE WITH CONNECTOR	
23	1D		E37-1304-05	LEAD WIRE WITH CONNECTOR	
24	1B		E37-1305-05	LEAD WIRE WITH CONNECTOR	
25	1C		E37-1306-05	LEAD WIRE WITH CONNECTOR	
26	2C		E37-1307-05	LEAD WIRE WITH CONNECTOR	
27	2D		E37-1308-05	LEAD WIRE WITH CONNECTOR	
28	1D		E37-1310-05	LEAD WIRE WITH CONNECTOR	
29	3B		E37-1311-05	LEAD WIRE WITH CONNECTOR	
30	2D		E37-1313-05	LEAD WIRE WITH CONNECTOR	
31	3B		E37-1314-05	LEAD WIRE WITH CONNECTOR	
32	3B		E37-1315-05	LEAD WIRE WITH CONNECTOR	
33	2B		E37-1316-05	LEAD WIRE WITH CONNECTOR	
34	1E		E37-1381-05	LEAD WIRE WITH CONNECTOR	
36	1D,1E		F05-1537-05	BLADE FUSE (15A/32V)      ACCESSORY	
37	2A		F07-1930-05	COVER (FAN)	
38	1D		F09-0445-05	CAP (25P)	
39	3B		F09-0484-05	CAP (9P)	
40	2A		F09-0491-05	FANMOTOR	
42	3A		G10-1343-04	FIBROUS SHEET (FRONT PANEL)	
43	1B		G10-1395-04	FIBROUS SHEET (SHIELDING CASE)	
44	3C		G10-1396-04	FIBROUS SHEET (SHIELDING COVER)	
45	2B		G11-4408-04	RUBBER SHEET (CONT-TR)	
47	3A		G13-2163-04	CUSHION (PF)	
50	1A		G13-2282-04	CONDUCTIVE CUSHION	
52	3B		J19-5496-02	HOLDER (DISP)	
53	1C		J19-5497-05	HOLDER (COMPACT-FLASH)	
54	1E		J29-0725-04	BRACKET (SIDE)	
55	3A		J39-0655-03	SPACER (SP)	
56	2D		J61-0307-05	BAND (DC)	
58	1E		K01-0421-05	HANDLE      ACCESSORY	
59	3A		K29-4539-04	KNOB (VOLUME)	
61	1F		L79-1419-05	LINE FILTER (DC)	

Ref. No.	Address	New parts	Parts No.	Description	Destination
A	1E		N08-0563-04	DRESSED SCREW (FRONT GLASS)	
B	3B,1D		N09-2292-05	HEXAGON HEAD SCREW (DSUB)	
C	1C		N30-2008-43	PAN HEAD MACHINE SCREW (CF)	
D	2C,1D		N30-2606-48	PAN HEAD MACHINE SCREW (BNC)	
E	2A		N30-3035-43	PAN HEAD MACHINE SCREW (FUN)	
F	2D,3D		N32-3006-43	FLAT HEAD MACHINE SCREW (TOP,REAR)	
G	3A,1E		N32-4008-43	FLAT HEAD MACHINE SCREW (PANEL,BKT)	
H	1B,1C		N67-3008-48	PAN HEAD SEMS SCREW (AVR)	
J	3B		N80-2006-43	PAN HEAD TAPTITE SCREW (DISP)	
K	1D		N80-2608-43	PAN HEAD TAPTITE SCREW (FUSE)	
L	1B,2C		N87-2608-48	BRAZIER HEAD TAPTITE SCREW (PCB)	
64	3A		T07-0347-15	SPEAKER	
<b>FINAL UNIT (X45-3862-71)</b>					
C1,2			CD04BD1H101M	ELECTRO 100UF 50WV	
C7,8			CE32BM1V220M	CHIP EL 22UF 35WV	
C10,11			CK73GB1H471K	CHIP C 470PF K	
C15-17			CK73GB1H103K	CHIP C 0.010UF K	
C21			CK73GB1H471K	CHIP C 470PF K	
C25,26			CK73GB1H103K	CHIP C 0.010UF K	
C29,30			CK73GB1H471K	CHIP C 470PF K	
C32,33			CE32BM1V220M	CHIP EL 22UF 35WV	
C36			CK73GB1H471K	CHIP C 470PF K	
C37			CK73GB1H103K	CHIP C 0.010UF K	
C38			CE32BM1V220M	CHIP EL 22UF 35WV	
C39			CK73GB1H471K	CHIP C 470PF K	
C40			CK73GB1H103K	CHIP C 0.010UF K	
C41,42			CK73GB1H471K	CHIP C 470PF K	
C44			CE32CL1V100M	CHIP EL 10UF 35WV	
C46			CK73GB1H471K	CHIP C 470PF K	
C47			CK73GB1H103K	CHIP C 0.010UF K	
C49			CK73GB1H473K	CHIP C 0.047UF K	
C50-52			CK73GB1H471K	CHIP C 470PF K	
C53			CK73GB1H103K	CHIP C 0.010UF K	
C55			CC73GCH1H100D	CHIP C 10PF D	
C59			CK73GB1H103K	CHIP C 0.010UF K	
C60			C93-0564-05	CHIP C 22PF J	
C61			CK73GB1H471K	CHIP C 470PF K	
C62			CK73GB1H103K	CHIP C 0.010UF K	
C63-65			CK73GB1H471K	CHIP C 470PF K	
C67			CK73GB1H471K	CHIP C 470PF K	
C68			CE32CL1V100M	CHIP EL 10UF 35WV	
C70			CK73GB1H103K	CHIP C 0.010UF K	
C71-75			CK73GB1H471K	CHIP C 470PF K	
C77,78			CK73GB1H471K	CHIP C 470PF K	
C80			CK73GB1H103K	CHIP C 0.010UF K	
C82			CK73GB1H104K	CHIP C 0.10UF K	
C83			CK73GB1H471K	CHIP C 470PF K	
C85			CC73GCH1H080D	CHIP C 8.0PF D	
C86			CK73GB1H103K	CHIP C 0.010UF K	
C87			CC73GCH1H100D	CHIP C 10PF D	
C88-90			CK73GB1H471K	CHIP C 470PF K	
C94			CC73GCH1H101J	CHIP C 100PF J	

## PARTS LIST

### FINAL UNIT (X45-3862-71)

Ref. No.	Address	New parts	Parts No.	Description	Destination	Ref. No.	Address	New parts	Parts No.	Description	Destination
C95-102			CK73GB1H471K	CHIP C 470PF K		C916			CK73GB1H102K	CHIP C 1000PF K	
C104			CK73GB1H471K	CHIP C 470PF K		CN1			E04-0193-05	PIN SOCKET	
C105			C93-0599-05	CHIP C 470PF K		CN2			E23-0902-05	TERMINAL	
C106			CK73GB1H471K	CHIP C 470PF K		CN8			E41-2671-05	PIN ASSY	
C108,109			CK73GB1H471K	CHIP C 470PF K		CN11			E41-2673-05	PIN ASSY	
						CN12			E41-2672-05	PIN ASSY	
C112			CK73GB1H471K	CHIP C 470PF K		CN15			E41-2672-05	PIN ASSY	
C113,114			CK73GB1H472K	CHIP C 4700PF K		CN19			E04-0193-05	PIN SOCKET	
C115			CK73GB1H471K	CHIP C 470PF K		CN20			E40-6656-05	PIN ASSY	
C116			C93-0552-05	CHIP C 2.0PF C		CN501			E23-0762-05	TERMINAL	
C117			CK73GB1H103K	CHIP C 0.010UF K		CN701			E41-2741-05	PIN ASSY	
C119			CC73GCH1H070B	CHIP C 7.0PF B		CN905			E41-1483-05	PIN ASSY	
C122			C93-0563-05	CHIP C 18PF J		J901			E58-0526-05	MODULAR JACK	
C123			C93-0564-05	CHIP C 22PF J		CN4			J13-0071-05	FUSE HOLDER	
C124			CK73GB1H471K	CHIP C 470PF K		L1,2			L92-0179-05	CHIP FERRITE	
C126			C93-0555-05	CHIP C 5.0PF C		L3			L79-1938-05	FILTER	
C127,128			CK73GB1H471K	CHIP C 470PF K		L4			L92-0131-05	CHIP FERRITE	
C130			C93-0559-05	CHIP C 9.0PF D		L5			L34-4518-05	AIR-CORE COIL	
C132			C93-0559-05	CHIP C 9.0PF D		L9			L34-4638-05	AIR-CORE COIL	
C133,134			CK73GB1H471K	CHIP C 470PF K		L10			L34-4645-15	AIR-CORE COIL	
C137			C93-0557-05	CHIP C 7.0PF D		L12-15			L34-4518-05	AIR-CORE COIL	
C138			CE32CL1V100M	CHIP EL 10UF 35WV		L17			L34-4523-05	AIR-CORE COIL	
C141			C93-0564-05	CHIP C 22PF J		L18			L41-6868-14	SMALL FIXED INDUCTOR (6.8NH)	
C149			C93-0557-05	CHIP C 7.0PF D		L20			L92-0179-05	CHIP FERRITE	
C150,151			CC73GCH1H100D	CHIP C 10PF D		L26			L92-0179-05	CHIP FERRITE	
C153,154			CC73GCH1H101J	CHIP C 100PF J		L27			L34-4517-05	AIR-CORE COIL	
C155-157			CC73GCH1H100D	CHIP C 10PF D		L701,702			L41-4705-33	SMALL FIXED INDUCTOR (47UH)	
C162			CK73GB1H104K	CHIP C 0.10UF K		L703,704			L41-1095-33	SMALL FIXED INDUCTOR (1.0UH)	
C163			CC73GCH1H100D	CHIP C 10PF D		L900			L92-0447-05	BEADS CORE	
C166			CC73GCH1H100D	CHIP C 10PF D		CP1			RK75GB1J103J	CHIP-COM 10K J 1/16W	
C187,188			C92-0905-05	OS-CON 47UF 35WV		R1			RK73FB2B102J	CHIP R 1.0K J 1/8W	
C189			CK73GB1H103K	CHIP C 0.010UF K		R2			RK73FB2B5R6J	CHIP R 5.6 J 1/8W	
C190			CK73GB1H471K	CHIP C 470PF K		R3			RK73FB2B102J	CHIP R 1.0K J 1/8W	
C191			CK73GB1E105K	CHIP C 1.0UF K		R4			R92-3627-05	CHIP R 0.005 D 1.0W	
C194			CC73FCH1H050C	CHIP C 5.0PF C		R9			RK73GB2A101J	CHIP R 100 J 1/10W	
C195			CC73FCH1H100D	CHIP C 10PF D		R12,13			RK73GB2A473J	CHIP R 47K J 1/10W	
C196			CC73FCH1H180J	CHIP C 18PF J		R15			RK73GB2A332J	CHIP R 3.3K J 1/10W	
C701			CK73GB1E105K	CHIP C 1.0UF K		R17			RK73GB2A103J	CHIP R 10K J 1/10W	
C702,703			CK73GB1H471K	CHIP C 470PF K		R20			RK73GB2A104J	CHIP R 100K J 1/10W	
C704			CE32AU1E100M	CHIP EL 10UF 25WV		R21,22			RK73GB2A824J	CHIP R 820K J 1/10W	
C705			CK73GB1E105K	CHIP C 1.0UF K		R23			RK73FB2B000J	CHIP R 0.0 J 1/8W	
C706,707			CK73GB1H471K	CHIP C 470PF K		R25			RK73GB2A104J	CHIP R 100K J 1/10W	
C708			CE32CL1V100M	CHIP EL 10UF 35WV		R26			RK73EB2E121J	CHIP R 120 J 1/4W	
C709			CE32AU1C330M	CHIP EL 33UF 16WV		R27			RK73GB2A224J	CHIP R 220K J 1/10W	
C710			CK73GB1H104K	CHIP C 0.10UF K		R28			RK73GB2A474J	CHIP R 470K J 1/10W	
C711			CS77CB21C100M	CHIP TNL 10UF 16WV		R29,30			RK73GB2A103J	CHIP R 10K J 1/10W	
C712			CE32AU1C330M	CHIP EL 33UF 16WV		R31,32			RK73GB2A104J	CHIP R 100K J 1/10W	
C713,714			CK73GB1H104K	CHIP C 0.10UF K		R33			RK73GB2A684J	CHIP R 680K J 1/10W	
C715			CE32AU1C330M	CHIP EL 33UF 16WV		R34			RK73FB2B8R2J	CHIP R 8.2 J 1/8W	
C716			CK73GB1H104K	CHIP C 0.10UF K		R35,36			RK73GB2A683J	CHIP R 68K J 1/10W	
C717,718			CK73GB1H471K	CHIP C 470PF K		R37			RK73GB2A684J	CHIP R 680K J 1/10W	
C900			CK73GB1H104K	CHIP C 0.10UF K		R38			RK73FB2B151J	CHIP R 150 J 1/8W	
C901			CK73GB1H102K	CHIP C 1000PF K		R39,40			RK73GB2A824J	CHIP R 820K J 1/10W	
C902			CC73GCH1H101J	CHIP C 100PF J		R41			RK73GB2A000J	CHIP R 0.0 J 1/10W	
C904			CC73GCH1H101J	CHIP C 100PF J		R42			RK73FB2B8R2J	CHIP R 8.2 J 1/8W	
C905			CK73FB0J106K	CHIP C 10UF K		R44			RK73FB2B8R2J	CHIP R 8.2 J 1/8W	
C906-908			CK73GB1H102K	CHIP C 1000PF K		R45,46			RK73GB2A000J	CHIP R 0.0 J 1/10W	
C909,910			CC73GCH1H101J	CHIP C 100PF J		R47			RK73FB2B151J	CHIP R 150 J 1/8W	
C912,913			CC73GCH1H101J	CHIP C 100PF J							
C914			CK73GB1H104K	CHIP C 0.10UF K							
C915			CC73GCH1H101J	CHIP C 100PF J							



## PARTS LIST

FINAL UNIT (X45-3862-71)  
RX UNIT (X55-3102-72)

Ref. No.	Address	New parts	Parts No.	Description	Destination
R49			RK73GB2A000J	CHIP R 0.0 J 1/10W	
R50,51			RK73GB2A104J	CHIP R 100K J 1/10W	
R52			RK73FB2B8R2J	CHIP R 8.2 J 1/8W	
R53,54			RK73GB2A154J	CHIP R 150K J 1/10W	
R55-58			RK73GB2A104J	CHIP R 100K J 1/10W	
R59,60			RK73GB2A103J	CHIP R 10K J 1/10W	
R61			RK73EB2E101J	CHIP R 100 J 1/4W	
R62			RK73GH2A513D	CHIP R 51K D 1/10W	
R63			RK73GH2A333D	CHIP R 33K D 1/10W	
R64			RK73GB2A474J	CHIP R 470K J 1/10W	
R65			RK73GB2A473J	CHIP R 47K J 1/10W	
R66			RK73GB2A100J	CHIP R 10 J 1/10W	
R67			RS14DB3D560J	FL-PROOF RS 56 J 2W	
R68			RK73GB2A104J	CHIP R 100K J 1/10W	
R69			RK73GB2A103J	CHIP R 10K J 1/10W	
R70-72			RK73GB2A000J	CHIP R 0.0 J 1/10W	
R75,76			RK73GB2A472J	CHIP R 4.7K J 1/10W	
R78			RK73GB2A104J	CHIP R 100K J 1/10W	
R89			RK73GB2A000J	CHIP R 0.0 J 1/10W	
R92			RK73GB2A104J	CHIP R 100K J 1/10W	
R102			RK73GH2A101D	CHIP R 100 D 1/10W	
R104			RK73GB2A393J	CHIP R 39K J 1/10W	
R121			RK73GH2A103D	CHIP R 10K D 1/10W	
R123			RK73GB2A103J	CHIP R 10K J 1/10W	
R124			RK73FB2B270J	CHIP R 27 J 1/8W	
R125			R92-1061-05	JUMPER REST 0 OHM	
R140			RK73GB2A103J	CHIP R 10K J 1/10W	
R142			RK73GB2A000J	CHIP R 0.0 J 1/10W	
R145			RK73GB2A000J	CHIP R 0.0 J 1/10W	
R150			RK73GB2A000J	CHIP R 0.0 J 1/10W	
R900			RK73GB2A000J	CHIP R 0.0 J 1/10W	
R901			RK73GB2A182J	CHIP R 1.8K J 1/10W	
R902			RK73GB2A000J	CHIP R 0.0 J 1/10W	
R903			RK73GB2A681J	CHIP R 680 J 1/10W	
R905,906			RK73GB2A000J	CHIP R 0.0 J 1/10W	
R907			RK73GH2A153D	CHIP R 15K D 1/10W	
R909			RK73GB2A000J	CHIP R 0.0 J 1/10W	
R910			RK73GB2A182J	CHIP R 1.8K J 1/10W	
R911,912			RK73GB2A000J	CHIP R 0.0 J 1/10W	
R914			RK73GB2A222J	CHIP R 2.2K J 1/10W	
R915			RS14DB3A4R7J	FL-PROOF RS 4.7 J 1W	
VR1			R32-0744-05	SEMI FIXED VARIABLE RESISTOR	
VR2			R32-0754-05	SEMI FIXED VARIABLE RESISTOR	
VR902			R31-0668-15	VARIABLE RESISTOR	
D4			Z5W27V	SURGE ABSORBER	
D5			DSA3A1-FK	DIODE	
D6			1SS355	DIODE	
D7			02CZ5.6(Y)F	ZENER DIODE	
D9,10			HSB88WS	DIODE	
D11			L7091CER	DIODE	
D14-16			L7091CER	DIODE	
D902			AVRM16270MABB	VARISTOR	
IC1			LTC6101BIS5-F	ANALOGUE IC	
IC2			NJM2904E-ZB	ANALOGUE IC	
IC3			TA78L05FF	MOS-IC	
IC4-6			NJM2904E-ZB	ANALOGUE IC	
IC7			S-8130AC	MOS-IC	
IC8			NJM2904E-ZB	ANALOGUE IC	
IC9			S24CS02AFJTBG	ROM IC	

Ref. No.	Address	New parts	Parts No.	Description	Destination
IC10	1A		RA45H4047M131	MOS-IC	
IC11	1B		NJM7808FA-ZB	BI-POLAR IC	
IC12	1B	*	NJM2388F10-ZB	BI-POLAR IC	
IC701			NJM78L05UA-ZB	BI-POLAR IC	
IC702			LTC1046IS8	MOS-IC	
IC703			TK72130CS	BI-POLAR IC	
Q2			SSM3K15TE(F)	FET	
Q4			2SJ506-E(S)	FET	
Q5,6			SSM3K15TE(F)	FET	
Q8			SSM3K15TE(F)	FET	
<b>CONTROL UNIT (X53-4132-71)</b>					
Refer to B51-8854-00 service manual.					
<b>CONTROL UNIT (X53-4140-10)</b>					
Refer to B51-8854-00 service manual.					
<b>RX UNIT (X55-3102-72)</b>					
D21			B30-2230-05	LED (YELLOW)	
C7			CC73GCH1H471J	CHIP C 470PF J	
C10			CC73GCH1H080B	CHIP C 8.0PF B	
C12			CC73GCH1H060B	CHIP C 6.0PF B	
C14			CC73GCH1H471J	CHIP C 470PF J	
C15			CK73GB1H104K	CHIP C 0.10UF K	
C17			CC73GCH1H471J	CHIP C 470PF J	
C18			CK73GB1H104K	CHIP C 0.10UF K	
C19			CC73GCH1H471J	CHIP C 470PF J	
C24			CC73GCH1H471J	CHIP C 470PF J	
C25			CK73GB1H104K	CHIP C 0.10UF K	
C26			CC73GCH1H471J	CHIP C 470PF J	
C27			CK73GB1H102K	CHIP C 1000PF K	
C32			CC73GCH1H151J	CHIP C 150PF J	
C33			CC73GCH1H271J	CHIP C 270PF J	
C34,35			CC73GCH1H471J	CHIP C 470PF J	
C36			CK73GB1H102K	CHIP C 1000PF K	
C37			CK73FB1E224K	CHIP C 0.22UF K	
C38			CS77CA1VR33M	CHIP TNTL 0.33UF 35WV	
C39			CC73GCH1H271J	CHIP C 270PF J	
C41,42			CC73GCH1H471J	CHIP C 470PF J	
C43			CC73GCH1H561J	CHIP C 560PF J	
C44			CK73GB1H103K	CHIP C 0.010UF K	
C45			CK73GB1H104K	CHIP C 0.10UF K	
C46			CC73GCH1H561J	CHIP C 560PF J	
C47			CC73GCH1H471J	CHIP C 470PF J	
C48			CK73GB1H104K	CHIP C 0.10UF K	
C50			CE32BM1E470M	CHIP EL 47UF 25WV	
C51			CK73GB1H104K	CHIP C 0.10UF K	
C53			CC73GCH1H271J	CHIP C 270PF J	
C54			CC73GCH1H101J	CHIP C 100PF J	
C55			CC73GCH1H080D	CHIP C 8.0PF D	
C56			CC73GCH1H271J	CHIP C 270PF J	
C58		*	CS77CB21C220M	CHIP TNTL 22UF 16WV	
C59			CK73GB1H104K	CHIP C 0.10UF K	
C60,61			CC73GCH1H471J	CHIP C 470PF J	
C62-66			CK73GB1H104K	CHIP C 0.10UF K	
C67		*	CS77CB21C220M	CHIP TNTL 22UF 16WV	
C68			CC73GCH1H101J	CHIP C 100PF J	

If a part reference number is listed in a shaded box, that part does not come with the PCB.

## PARTS LIST

### RX UNIT (X55-3102-72)

Ref. No.	Address	New parts	Parts No.	Description	Destination	Ref. No.	Address	New parts	Parts No.	Description	Destination
C69			CC73GCH1H471J	CHIP C 470PF J		C162			CC73GCH1H070D	CHIP C 7.0PF D	
C70		*	CS77CC1C330M	CHIP TNTL 33UF 16WV		C163			CC73GCH1H020B	CHIP C 2.0PF B	
C74			CC73GCH1H100C	CHIP C 10PF C		C164			CK73GB1H104K	CHIP C 0.10UF K	
C75		*	CS77CC1C330M	CHIP TNTL 33UF 16WV		C165			CS77CB21C100M	CHIP TNTL 10UF 16WV	
C76			CC73GCH1H330J	CHIP C 33PF J		C166			CC73GCH1H220J	CHIP C 22PF J	
C77			CK73GB1H104K	CHIP C 0.10UF K		C167			CC73GCH1H180J	CHIP C 18PF J	
C79			CS77BA1E010M	CHIP TNTL 1.0UF 25WV		C168			CC73GCH1H471J	CHIP C 470PF J	
C81			CK73GB1H104K	CHIP C 0.10UF K		C169			CC73GCH1H120J	CHIP C 12PF J	
C83-85			CC73GCH1H471J	CHIP C 470PF J		C170,171			CK73GB1H104K	CHIP C 0.10UF K	
C86			CC73GCH1H100C	CHIP C 10PF C		C172			CK73GB1H473K	CHIP C 0.047UF K	
C87			CK73GB1H104K	CHIP C 0.10UF K		C173,174			CK73GB1H103K	CHIP C 0.010UF K	
C88			CK73GB1H103K	CHIP C 0.010UF K		C175			CC73GCH1H101J	CHIP C 100PF J	
C89			CC73GCH1H390J	CHIP C 39PF J		C176			CK73GB1H104K	CHIP C 0.10UF K	
C90			CK73GB1H103K	CHIP C 0.010UF K		C177-179			CC73GCH1H471J	CHIP C 470PF J	
C91			CC73GCH1H180G	CHIP C 18PF G		C180			CK73GB1H104K	CHIP C 0.10UF K	
C92			CC73FCH1H060B	CHIP C 6.0PF B		C183			CE32AU1E100M	CHIP EL 10UF 25WV	
C93			CC73FCH1H050B	CHIP C 5.0PF B		C185,186			CC73GCH1H471J	CHIP C 470PF J	
C94,95			CC73FCH1H030B	CHIP C 3.0PF B		C187			CC73GCH1H220J	CHIP C 22PF J	
C96			CE32BM1E470M	CHIP EL 47UF 25WV		C188			CK73GB1H103K	CHIP C 0.010UF K	
C97			CK73GB1H104K	CHIP C 0.10UF K		C192			CC73GCH1H471J	CHIP C 470PF J	
C98,99			CC73GCH1H471J	CHIP C 470PF J		C193			CK73GB1H104K	CHIP C 0.10UF K	
C100			CK73GB1H103K	CHIP C 0.010UF K		C194			CC73GCH1H080D	CHIP C 8.0PF D	
C102			CC73GCH1H471J	CHIP C 470PF J		C195			CC73GCH1H471J	CHIP C 470PF J	
C103			CC73GCH1H050B	CHIP C 5.0PF B		C196,197			CK73GB1H103K	CHIP C 0.010UF K	
C104			CC73GCH1H471J	CHIP C 470PF J		C198			CC73GCH1H471J	CHIP C 470PF J	
C105,106			CC73FCH1H050B	CHIP C 5.0PF B		C199			CK73GB1H103K	CHIP C 0.010UF K	
C107			CC73GCH1H330J	CHIP C 33PF J		C203-205			CC73GCH1H471J	CHIP C 470PF J	
C108			CC73GCH1H560J	CHIP C 56PF J		C206			CC73GCH1H100C	CHIP C 10PF C	
C109,110			CK73GB1H103K	CHIP C 0.010UF K		C211,212			CK73GB1H103K	CHIP C 0.010UF K	
C112			CC73GCH1H220J	CHIP C 22PF J		C213			CK73GB1H473K	CHIP C 0.047UF K	
C113			CC73FCH1H060B	CHIP C 6.0PF B		C214			CC73GCH1H040C	CHIP C 4.0PF C	
C114			CC73FCH1H050B	CHIP C 5.0PF B		C215			CK73GB1H103K	CHIP C 0.010UF K	
C115			CC73GCH1H100D	CHIP C 10PF D		C216			CK73GB1H473K	CHIP C 0.047UF K	
C116			CC73GCH1H560J	CHIP C 56PF J		C217			CK73GB1H104K	CHIP C 0.10UF K	
C117			CC73GCH1H121J	CHIP C 120PF J		C218			CK73GB1H473K	CHIP C 0.047UF K	
C118-120			CC73GCH1H471J	CHIP C 470PF J		C220			CC73GCH1H040C	CHIP C 4.0PF C	
C122			CC73GCH1H100D	CHIP C 10PF D		C221,222			CK73GB1H104K	CHIP C 0.10UF K	
C123			CC73FCH1H060B	CHIP C 6.0PF B		C223			CK73GB1H103K	CHIP C 0.010UF K	
C124			CC73FCH1H050B	CHIP C 5.0PF B		C224			CK73GB1H104K	CHIP C 0.10UF K	
C125			CC73GCH1H100D	CHIP C 10PF D		C225			CK73GB1H473K	CHIP C 0.047UF K	
C126			CK73GB1H104K	CHIP C 0.10UF K		C227			CC73GCH1H471J	CHIP C 470PF J	
C128			CC73GCH1H560J	CHIP C 56PF J		C228,229			CK73FB1E474K	CHIP C 0.47UF K	
C129,130			CK73GB1H103K	CHIP C 0.010UF K		C230			CC73GCH1H820J	CHIP C 82PF J	
C131		*	CS77CC1C330M	CHIP TNTL 33UF 16WV		C231			CK73GB1H473K	CHIP C 0.047UF K	
C132-134			CC73GCH1H471J	CHIP C 470PF J		C232			CC73GCH1H470J	CHIP C 47PF J	
C137			CC73GCH1H050B	CHIP C 5.0PF B		C233			CK73GB1H473K	CHIP C 0.047UF K	
C138			CC73GCH1H180J	CHIP C 18PF J		C234,235			CC73GCH1H270J	CHIP C 27PF J	
C139			CE32BM1E470M	CHIP EL 47UF 25WV		C236			CK73GB1H104K	CHIP C 0.10UF K	
C140,141			CK73GB1H103K	CHIP C 0.010UF K		C237			CK73GB1H102K	CHIP C 1000PF K	
C142,143			CC73FCH1H0R5C	CHIP C 0.5PF C		C238			CC73GCH1H090D	CHIP C 9.0PF D	
C144-146			CK73GB1H104K	CHIP C 0.10UF K		C239			CE32AU1C330M	CHIP EL 33UF 16WV	
C147		*	CS77CC1C330M	CHIP TNTL 33UF 16WV		C240			CS77CB21C100M	CHIP TNTL 10UF 16WV	
C149			CC73GCH1H220J	CHIP C 22PF J		C241,242			CC73GCH1H150J	CHIP C 15PF J	
C150			CC73GCH1H180J	CHIP C 18PF J		C243			CC73GCH1H820J	CHIP C 82PF J	
C151			CC73GCH1H120J	CHIP C 12PF J		C244			CC73GCH1H100D	CHIP C 10PF D	
C154,155			CK73GB1H104K	CHIP C 0.10UF K		C245			CK73GB1H102K	CHIP C 1000PF K	
C156			CC73GCH1H100C	CHIP C 10PF C		C248			CC73GCH1H471J	CHIP C 470PF J	
C157,158			CC73GCH1H471J	CHIP C 470PF J		C249			CC73GCH1H080D	CHIP C 8.0PF D	
C159,160			CK73GB1H104K	CHIP C 0.10UF K		C250,251			CK73GB1H104K	CHIP C 0.10UF K	
C161			CC73GCH1H1R5C	CHIP C 1.5PF C		C252			CC73GCH1H151J	CHIP C 150PF J	

## PARTS LIST

RX UNIT (X55-3102-72)

Ref. No.	Address	New parts	Parts No.	Description	Desti-nation	Ref. No.	Address	New parts	Parts No.	Description	Desti-nation
C253			CC73GCH1H010C	CHIP C 1.0PF C		C337			CC73GCH1H560J	CHIP C 56PF J	
C254			CC73GCH1H030C	CHIP C 3.0PF C		C340		*	CS77CC1C330M	CHIP TNTL 33UF 16WV	
C255			CK73GB1H104K	CHIP C 0.10UF K		C341,342			CK73GB1H473K	CHIP C 0.047UF K	
C256			CK73GB1H102K	CHIP C 1000PF K		C343			CC73GCH1H220J	CHIP C 22PF J	
C257			CK73GB1H103K	CHIP C 0.010UF K		C347,348			CK73GB1H103K	CHIP C 0.010UF K	
C258			CK73GB1H473K	CHIP C 0.047UF K		C349			CC73GCH1H680J	CHIP C 68PF J	
C260			CC73GCH1H471J	CHIP C 470PF J		C350		*	CS77CC1C330M	CHIP TNTL 33UF 16WV	
C261			CK73GB1H103K	CHIP C 0.010UF K		C351			CK73GB1H102K	CHIP C 1000PF K	
C262,263			CK73GB1H102K	CHIP C 1000PF K		C352			CK73GB1H473K	CHIP C 0.047UF K	
C264			CS77CA1ER47M	CHIP TNTL 0.47UF 25WV		C353			CK73GB1H102K	CHIP C 1000PF K	
C265			CC73GCH1H470J	CHIP C 47PF J		C355			CK73GB1H103K	CHIP C 0.010UF K	
C266,267			CC73GCH1H471J	CHIP C 470PF J		C356			CK73GB1H473K	CHIP C 0.047UF K	
C268,269			CK73GB1H473K	CHIP C 0.047UF K		C357			CK73GB1H103K	CHIP C 0.010UF K	
C270		*	CS77CA1DR68M	CHIP TNTL 0.68UF 20WV		C358			CK73GB1H473K	CHIP C 0.047UF K	
C271			CC73GCH1H471J	CHIP C 470PF J		C359,360			CC73GCH1H471J	CHIP C 470PF J	
C272			CK73GB1H104K	CHIP C 0.10UF K		C361			CK73GB1H102K	CHIP C 1000PF K	
C273			CC73GCH1H220J	CHIP C 22PF J		C362			CC73GCH1H270J	CHIP C 27PF J	
C274			CK73GB1H473K	CHIP C 0.047UF K		C363			CK73GB1H473K	CHIP C 0.047UF K	
C277			CK73GB1H102K	CHIP C 1000PF K		C365,366			CK73GB1H104K	CHIP C 0.10UF K	
C278			CC73GCH1H080D	CHIP C 8.0PF D		C367,368			CC73GCH1H330J	CHIP C 33PF J	
C279			CK73GB1H473K	CHIP C 0.047UF K		C369,370			CK73FB1E474K	CHIP C 0.47UF K	
C280			CC73GCH1H080B	CHIP C 8.0PF B		C371			CK73GB1H102K	CHIP C 1000PF K	
C281			CC73GCH1H030B	CHIP C 3.0PF B		C372			CK73GB1H473K	CHIP C 0.047UF K	
C282		*	CS77CB21C150M	CHIP TNTL 15UF 16WV		C373			CK73GB1H103K	CHIP C 0.010UF K	
C284			CK73GB1H473K	CHIP C 0.047UF K		C375			CK73GB1H103K	CHIP C 0.010UF K	
C285			CC73GCH1H471J	CHIP C 470PF J		C377			CK73GB1H103K	CHIP C 0.010UF K	
C287			CC73GCH1H390J	CHIP C 39PF J		C379			CC73GCH1H121J	CHIP C 120PF J	
C288,289			CC73GCH1H150J	CHIP C 15PF J		C380			CC73GCH1H560J	CHIP C 56PF J	
C290,291			CK73GB1H473K	CHIP C 0.047UF K		C381			CE32BM1E470M	CHIP EL 47UF 25WV	
C292			CE32CL1V100M	CHIP EL 10UF 35WV		C382,383			CK73GB1H104K	CHIP C 0.10UF K	
C295			CK73GB1H102K	CHIP C 1000PF K		C385,386			CK73GB1H104K	CHIP C 0.10UF K	
C296		*	CS77CA1DR68M	CHIP TNTL 0.68UF 20WV		C387			CC73GCH1H270J	CHIP C 27PF J	
C297			CC73GCH1H120J	CHIP C 12PF J		C388			CC73GCH1H820J	CHIP C 82PF J	
C298			CK73GB1H102K	CHIP C 1000PF K		C389			CK73GB1H473K	CHIP C 0.047UF K	
C300			CC73GCH1H220G	CHIP C 22PF G		C390			CK73GB1H104K	CHIP C 0.10UF K	
C301			CK73GB1H473K	CHIP C 0.047UF K		C391,392			CK73GB1H103K	CHIP C 0.010UF K	
C302			CC73GCH1H100D	CHIP C 10PF D		C394,395			CK73GB1H102K	CHIP C 1000PF K	
C303,304			CK73GB1H473K	CHIP C 0.047UF K		C396-398			CK73GB1H104K	CHIP C 0.10UF K	
C306			CK73GB1H102K	CHIP C 1000PF K		C400			CC73GCH1H220J	CHIP C 22PF J	
C307,308			CK73GB1H103K	CHIP C 0.010UF K		C401			CK73GB1H473K	CHIP C 0.047UF K	
C309			CC73GCH1H471J	CHIP C 470PF J		C402			CC73GCH1H560J	CHIP C 56PF J	
C310			CK73GB1H102K	CHIP C 1000PF K		C403			CK73GB1H104K	CHIP C 0.10UF K	
C311			CC73GCH1H080D	CHIP C 8.0PF D		C405			CK73GB1H102K	CHIP C 1000PF K	
C314			CK73GB1H104K	CHIP C 0.10UF K		C406			CK73GB1H103K	CHIP C 0.010UF K	
C315			CC73GCH1H270G	CHIP C 27PF G		C407			CC73GCH1H560J	CHIP C 56PF J	
C316			CK73GB1H473K	CHIP C 0.047UF K		C408			CC73GCH1H220J	CHIP C 22PF J	
C317			CC73GCH1H151J	CHIP C 150PF J		C409			CK73GB1H102K	CHIP C 1000PF K	
C318,319			CK73GB1H103K	CHIP C 0.010UF K		C410			CK73GB1H104K	CHIP C 0.10UF K	
C320			CE32BM1E470M	CHIP EL 47UF 25WV		C411			CC73GCH1H121J	CHIP C 120PF J	
C324			CC73GCH1H471J	CHIP C 470PF J		C412			CK73GB1H104K	CHIP C 0.10UF K	
C325			CC73GCH1H270G	CHIP C 27PF G		C413			CK73GB1H103K	CHIP C 0.010UF K	
C326			CC73GCH1H151J	CHIP C 150PF J		C414			CK73GB1H104K	CHIP C 0.10UF K	
C327			CK73GB1H102K	CHIP C 1000PF K		C415,416			CK73GB1H103K	CHIP C 0.010UF K	
C329			CK73GB1H103K	CHIP C 0.010UF K		C417			CK73GB1H104K	CHIP C 0.10UF K	
C330			CK73GB1H102K	CHIP C 1000PF K		C418,419			CK73GB1H103K	CHIP C 0.010UF K	
C331			CC73GCH1H020B	CHIP C 2.0PF B		C420			CK73GB1H102K	CHIP C 1000PF K	
C332			CK73GB1H104K	CHIP C 0.10UF K		C421,422			CK73GB1H473K	CHIP C 0.047UF K	
C333			CC73GCH1H151J	CHIP C 150PF J		C423,424			CK73GB1H103K	CHIP C 0.010UF K	
C334,335			CK73GB1H103K	CHIP C 0.010UF K		C425			CK73GB1H104K	CHIP C 0.10UF K	
C336			CC73GCH1H471J	CHIP C 470PF J		C427			CK73FB1E474K	CHIP C 0.47UF K	

## PARTS LIST

### RX UNIT (X55-3102-72)

Ref. No.	Address	New parts	Parts No.	Description	Destination	Ref. No.	Address	New parts	Parts No.	Description	Destination
C428,429			CC73GCH1H560J	CHIP C 56PF J		C524			CK73FB1H333K	CHIP C 0.033UF K	
C430			CK73GB1H102K	CHIP C 1000PF K		C527			CK73GB1H104K	CHIP C 0.10UF K	
C431			CK73GB1H473K	CHIP C 0.047UF K		C532			CK73GB1H104K	CHIP C 0.10UF K	
C432			CK73GB1H102K	CHIP C 1000PF K		C533-536			CE32CL1V100M	CHIP EL 10UF 35WV	
C434,435			CK73GB1H473K	CHIP C 0.047UF K		C537-540			CC73GCH1H471J	CHIP C 470PF J	
C437			CK73GB1H102K	CHIP C 1000PF K		C541,542			CK73GB1H104K	CHIP C 0.10UF K	
C438			CK73GB1H473K	CHIP C 0.047UF K		C543			CK73GB1H473K	CHIP C 0.047UF K	
C439			CK73GB1H104K	CHIP C 0.10UF K		C544			CC73GCH1H470J	CHIP C 47PF J	
C440-442			CK73FB1E474K	CHIP C 0.47UF K		C545-548			CC73GCH1H471J	CHIP C 470PF J	
C443,444			CK73GB1H473K	CHIP C 0.047UF K		C549			CC73GCH1H470J	CHIP C 47PF J	
C446			CE32AU1E100M	CHIP EL 10UF 25WV		C550-553			CK73GB1H103K	CHIP C 0.010UF K	
C447			CK73FB1E474K	CHIP C 0.47UF K		C554			CK73GB1H473K	CHIP C 0.047UF K	
C448			CK73GB1H104K	CHIP C 0.10UF K		C555			CE32BM1V220M	CHIP EL 22UF 35WV	
C449			CK73GB1H473K	CHIP C 0.047UF K		C556			CC73GCH1H471J	CHIP C 470PF J	
C450,451			CK73FB1E474K	CHIP C 0.47UF K		C557			CK73GB1H473K	CHIP C 0.047UF K	
C452,453			CK73GB1H104K	CHIP C 0.10UF K		C558			CC73GCH1H471J	CHIP C 470PF J	
C454,455			CK73FB1E474K	CHIP C 0.47UF K		C559			CK73GB1H104K	CHIP C 0.10UF K	
C456			CK73GB1H473K	CHIP C 0.047UF K		C560,561			CC73GCH1H471J	CHIP C 470PF J	
C458			CK73GB1H104K	CHIP C 0.10UF K		C562			CK73GB1H473K	CHIP C 0.047UF K	
C459			CC73GCH1H221J	CHIP C 220PF J		C563			CC73GCH1H471J	CHIP C 470PF J	
C460			CK73FB1E474K	CHIP C 0.47UF K		C564			CK73GB1H103K	CHIP C 0.010UF K	
C461			CC73GCH1H221J	CHIP C 220PF J		C565			CC73GCH1H471J	CHIP C 470PF J	
C462			CK73GB1H104K	CHIP C 0.10UF K		C566			CK73GB1H473K	CHIP C 0.047UF K	
C463-465			CK73FB1E474K	CHIP C 0.47UF K		C567			CE32CL1V100M	CHIP EL 10UF 35WV	
C466			CK73GB1H473K	CHIP C 0.047UF K		C568			CC73GCH1H470J	CHIP C 47PF J	
C467			CK73GB1H102K	CHIP C 1000PF K		C569			CC73GCH1H471J	CHIP C 470PF J	
C468			CK73GB1H104K	CHIP C 0.10UF K		C570			CC73GCH1H470J	CHIP C 47PF J	
C469			CK73GB1H473K	CHIP C 0.047UF K		C571			C92-0904-05	OS-CON 22UF 35WV	
C470			CC73GCH1H471J	CHIP C 470PF J		C572,573			CK73GB1H103K	CHIP C 0.010UF K	
C471,472			CK73GB1H104K	CHIP C 0.10UF K		C574-576			CK73GB1H104K	CHIP C 0.10UF K	
C473			CC73GCH1H270J	CHIP C 27PF J		C577			CK73GB1H103K	CHIP C 0.010UF K	
C474			CK73FB1E474K	CHIP C 0.47UF K		C578			CC73GCH1H151J	CHIP C 150PF J	
C476			CE32AU1E100M	CHIP EL 10UF 25WV		C579			CC73GCH1H560J	CHIP C 56PF J	
C477			CK73GB1H104K	CHIP C 0.10UF K		C580-582			CK73GB1H103K	CHIP C 0.010UF K	
C478			CK73FB1E474K	CHIP C 0.47UF K		C583			CK73GB1H102K	CHIP C 1000PF K	
C480-482			CE32CL1V100M	CHIP EL 10UF 35WV		C584			CK73GB1H103K	CHIP C 0.010UF K	
C484-488			CC73GCH1H471J	CHIP C 470PF J		C585			CC73GCH1H470J	CHIP C 47PF J	
C489			CK73GB1H102K	CHIP C 1000PF K		C586			CC73GCH1H471J	CHIP C 470PF J	
C491			CK73GB1H104K	CHIP C 0.10UF K		C587-590			CK73FB1E474K	CHIP C 0.47UF K	
C492			C93-0912-05	CHIP C 100UF M		C591			CK73GB1H102K	CHIP C 1000PF K	
C493			CK73GB1H473K	CHIP C 0.047UF K		C618			CC73GCH1H101J	CHIP C 100PF J	
C494			CK73FB0J106K	CHIP C 10UF K		C619			CK73GB1H104K	CHIP C 0.10UF K	
C495			CK73GB1H104K	CHIP C 0.10UF K		C620			CK73GB1H102K	CHIP C 1000PF K	
C498			CC73GCH1H470J	CHIP C 47PF J		C621,622			CK73GB1H104K	CHIP C 0.10UF K	
C499			CK73FB0J106K	CHIP C 10UF K		C624			CC73GCH1H101J	CHIP C 100PF J	
C500-504			CC73GCH1H471J	CHIP C 470PF J		C625			CE32BM1E470M	CHIP EL 47UF 25WV	
C505			CK73FB0J106K	CHIP C 10UF K		C626			CS77BA1E010M	CHIP TINTL 1.0UF 25WV	
C506			CK73GB1H102K	CHIP C 1000PF K		C628			CK73GB1H104K	CHIP C 0.10UF K	
C507			CK73GB1H104K	CHIP C 0.10UF K		C630			CK73GB1H104K	CHIP C 0.10UF K	
C508			CK73FB0J106K	CHIP C 10UF K		C652			CK73GB1H104K	CHIP C 0.10UF K	
C509			CC73GCH1H101J	CHIP C 100PF J		C655			CK73FB0J106K	CHIP C 10UF K	
C510			CK73GB1H104K	CHIP C 0.10UF K		C657			CC73GCH1H270J	CHIP C 27PF J	
C516			CK73GB1H473K	CHIP C 0.047UF K		C658			CK73FB1E474K	CHIP C 0.47UF K	
C517			CK73FB0J106K	CHIP C 10UF K		C659			CC73GCH1H101J	CHIP C 100PF J	
C518			CK73GB1H104K	CHIP C 0.10UF K		C660			CC73GCH1H050C	CHIP C 5.0PF C	
C519			CC73GCH1H471J	CHIP C 470PF J		C661			CK73GB1H104K	CHIP C 0.10UF K	
C520			CK73GB1H103K	CHIP C 0.010UF K		C671			CK73GB1H104K	CHIP C 0.10UF K	
C521			CK73GB1H104K	CHIP C 0.10UF K		C675			CE32AU1C330M	CHIP EL 33UF 16WV	
C522			CK73GB1H103K	CHIP C 0.010UF K		C677			CK73GB1H104K	CHIP C 0.10UF K	
C523			CK73GB1H104K	CHIP C 0.10UF K							

## PARTS LIST

RX UNIT (X55-3102-72)

Ref. No.	Address	New parts	Parts No.	Description	Destination	Ref. No.	Address	New parts	Parts No.	Description	Destination
CN1-4			E23-1280-05	TERMINAL		L55			L41-1575-33	SMALL FIXED INDUCTOR (0.015UH)	
CN5			E04-0460-05	RF COAXIAL RECEPTACLE (SMB)		L56			L41-8295-33	SMALL FIXED INDUCTOR (8.2UH)	
CN6			E41-2735-05	PIN ASSY		L57			L41-1075-33	SMALL FIXED INDUCTOR (0.01UH)	
CN8-35			E23-1280-05	TERMINAL		L58,59			L41-1885-33	SMALL FIXED INDUCTOR (0.18UH)	
CN36			E41-2735-05	PIN ASSY		L60,61			L41-2275-33	SMALL FIXED INDUCTOR (0.022UH)	
CN38,39			E23-1280-05	TERMINAL		L62			L41-1075-33	SMALL FIXED INDUCTOR (0.01UH)	
CN41			E04-0154-05	PIN SOCKET		L66,67			L41-8275-33	SMALL FIXED INDUCTOR (0.082UH)	
CN42			E40-6656-05	PIN ASSY		L68			L41-8295-33	SMALL FIXED INDUCTOR (8.2UH)	
CN43			E04-0193-05	PIN SOCKET		L69			L41-1595-33	SMALL FIXED INDUCTOR (1.5UH)	
CN44			E41-2672-05	PIN ASSY		L70			L41-3985-33	SMALL FIXED INDUCTOR (0.39UH)	
CN45			E04-0193-05	PIN SOCKET		L71			L41-1595-33	SMALL FIXED INDUCTOR (1.5UH)	
CN46,47			E41-2735-05	PIN ASSY		L72			L41-3985-33	SMALL FIXED INDUCTOR (0.39UH)	
CN61,62			E23-1280-05	TERMINAL		L73			L41-2285-33	SMALL FIXED INDUCTOR (0.22UH)	
E1			F10-2379-04	SHIELDING CASE		L74,75			L34-4748-05	COIL	
E2			F10-2409-04	SHIELDING CASE		L76			L41-1075-33	SMALL FIXED INDUCTOR (0.01UH)	
E3			F10-3080-04	SHIELDING CASE		L77			L92-0140-05	CHIP FERRITE	
CF1			L72-1019-05	CERAMIC FILTER (6MHZ)		L78			L41-1005-33	SMALL FIXED INDUCTOR (10UH)	
CF2			L72-1028-05	CERAMIC FILTER (450MHZ)		L79			L41-1095-33	SMALL FIXED INDUCTOR (1.0UH)	
CF3,4			L72-1027-05	CERAMIC FILTER (450MHZ)		L80			L41-1575-33	SMALL FIXED INDUCTOR (0.15UH)	
CF5,6			L72-1028-05	CERAMIC FILTER (450MHZ)		L81			L41-8285-33	SMALL FIXED INDUCTOR (0.82UH)	
CF7			L72-1027-05	CERAMIC FILTER (450MHZ)		L82			L41-1005-33	SMALL FIXED INDUCTOR (10UH)	
L2			L34-4616-05	AIR-CORE COIL		L83			L41-6895-33	SMALL FIXED INDUCTOR (6.8UH)	
L5			L34-4605-15	AIR-CORE COIL		L86			L41-1585-33	SMALL FIXED INDUCTOR (0.15UH)	
L8,9			L41-1075-33	SMALL FIXED INDUCTOR (0.01UH)		L87			L41-1005-33	SMALL FIXED INDUCTOR (10UH)	
L10			L41-6885-33	SMALL FIXED INDUCTOR (0.68UH)		L88			L41-8295-33	SMALL FIXED INDUCTOR (8.2UH)	
L11			L41-1295-33	SMALL FIXED INDUCTOR (1.2UH)		L89			L41-6895-33	SMALL FIXED INDUCTOR (6.8UH)	
L12			L34-4605-15	AIR-CORE COIL		L90,91			L34-4748-05	COIL	
L13			L41-1295-33	SMALL FIXED INDUCTOR (1.2UH)		L92			L41-1075-33	SMALL FIXED INDUCTOR (0.01UH)	
L14			L41-1805-33	SMALL FIXED INDUCTOR (18UH)		L93			L41-1085-33	SMALL FIXED INDUCTOR (0.1UH)	
L16			L41-2705-33	SMALL FIXED INDUCTOR (27UH)		L94,95			L39-1476-05	TOROIDAL COIL	
L17,18			L41-1098-40	SMALL FIXED INDUCTOR (1000NH)		L96			L41-6895-33	SMALL FIXED INDUCTOR (6.8UH)	
L20			L41-2705-33	SMALL FIXED INDUCTOR (27UH)		L97			L41-1005-33	SMALL FIXED INDUCTOR (10UH)	
L21,22			L41-1098-40	SMALL FIXED INDUCTOR (1000NH)		L98,99			L41-1895-33	SMALL FIXED INDUCTOR (1.8UH)	
L23			L41-2705-33	SMALL FIXED INDUCTOR (27UH)		L100			L41-3985-33	SMALL FIXED INDUCTOR (0.39UH)	
L26			L41-1095-33	SMALL FIXED INDUCTOR (1.0UH)		L101			L41-1595-33	SMALL FIXED INDUCTOR (1.5UH)	
L27			L41-1098-40	SMALL FIXED INDUCTOR (1000NH)		L102			L41-1005-33	SMALL FIXED INDUCTOR (10UH)	
L28			L34-4891-05	AIR-CORE COIL		L103			L41-3985-33	SMALL FIXED INDUCTOR (0.39UH)	
L29			L41-1098-40	SMALL FIXED INDUCTOR (1000NH)		L106			L41-1585-33	SMALL FIXED INDUCTOR (0.15UH)	
L30			L34-4891-05	AIR-CORE COIL		L107			L41-6895-33	SMALL FIXED INDUCTOR (6.8UH)	
L31			L41-2275-33	SMALL FIXED INDUCTOR (0.022UH)		L108,109			L41-4775-33	SMALL FIXED INDUCTOR (0.047UH)	
L32			L41-8275-33	SMALL FIXED INDUCTOR (0.082UH)		L110			L41-1585-33	SMALL FIXED INDUCTOR (0.15UH)	
L33			L41-2785-33	SMALL FIXED INDUCTOR (0.27UH)		L111			L41-1595-33	SMALL FIXED INDUCTOR (1.5UH)	
L34			L41-1205-33	SMALL FIXED INDUCTOR (12UH)		L112,113			L39-1476-05	TOROIDAL COIL	
L35			L41-3395-33	SMALL FIXED INDUCTOR (3.3UH)		L114			L41-6875-33	SMALL FIXED INDUCTOR (0.068UH)	
L36			L41-2275-33	SMALL FIXED INDUCTOR (0.022UH)		L115			L41-8275-33	SMALL FIXED INDUCTOR (0.082UH)	
L37			L41-1205-33	SMALL FIXED INDUCTOR (12UH)		L116,117			L41-1585-33	SMALL FIXED INDUCTOR (0.15UH)	
L38			L41-1095-33	SMALL FIXED INDUCTOR (1.0UH)		L118			L41-6875-33	SMALL FIXED INDUCTOR (0.068UH)	
L39			L41-2275-33	SMALL FIXED INDUCTOR (0.022UH)		L119			L41-2285-33	SMALL FIXED INDUCTOR (0.22UH)	
L40,41			L41-1098-40	SMALL FIXED INDUCTOR (1000NH)		L120			L41-8295-33	SMALL FIXED INDUCTOR (8.2UH)	
L42			L41-1575-33	SMALL FIXED INDUCTOR (0.015UH)		L121			L41-1595-33	SMALL FIXED INDUCTOR (1.5UH)	
L43,44			L41-3395-33	SMALL FIXED INDUCTOR (3.3UH)		L122			L41-1585-33	SMALL FIXED INDUCTOR (0.15UH)	
L45			L41-1575-33	SMALL FIXED INDUCTOR (0.015UH)		L123			L41-3395-33	SMALL FIXED INDUCTOR (3.3UH)	
L46,47			L34-4749-05	COIL		L124-126			L41-1585-33	SMALL FIXED INDUCTOR (0.15UH)	
L48			L41-1095-33	SMALL FIXED INDUCTOR (1.0UH)		L127			L41-8295-33	SMALL FIXED INDUCTOR (8.2UH)	
L49			L41-2705-33	SMALL FIXED INDUCTOR (27UH)		L128			L34-4725-05	COIL	
L50			L41-2275-33	SMALL FIXED INDUCTOR (0.022UH)		L129,130			L41-1005-33	SMALL FIXED INDUCTOR (10UH)	
L51			L92-0140-05	CHIP FERRITE		L131			L41-5685-33	SMALL FIXED INDUCTOR (0.56UH)	
L52,53			L34-4749-05	COIL		L132-135			L79-1853-05	HELICAL BLOCK	
L54			L41-1075-33	SMALL FIXED INDUCTOR (0.01UH)		L136,137			L41-3985-33	SMALL FIXED INDUCTOR (0.39UH)	
						XF1			L71-0661-05	MCF (49.95MHZ)	

## PARTS LIST

### RX UNIT (X55-3102-72)

Ref. No.	Address	New parts	Parts No.	Description	Destination	Ref. No.	Address	New parts	Parts No.	Description	Destination
XF2			L71-0660-05	MCF (49.95MHZ)		R82			RK73GB2A102J	CHIP R 1.0K J 1/10W	
XF3			L71-0648-05	MCF (49.95MHZ)		R83,84			RK73GB2A472J	CHIP R 4.7K J 1/10W	
XF4			L71-0647-05	MCF (49.95MHZ)		R85			RK73GB2A333J	CHIP R 33K J 1/10W	
R1			RK73GB2A102J	CHIP R 1.0K J 1/10W		R86			RK73GB2A104J	CHIP R 100K J 1/10W	
R2			RK73GB2A561J	CHIP R 560 J 1/10W		R88			RK73GB2A103J	CHIP R 10K J 1/10W	
R4			RK73FB2B121J	CHIP R 120 J 1/8W		R89			RK73GB2A100J	CHIP R 10 J 1/10W	
R8			RK73GB2A470J	CHIP R 47 J 1/10W		R90			RK73GB2A330J	CHIP R 33 J 1/10W	
R9			RK73GB2A332J	CHIP R 3.3K J 1/10W		R91			RK73GB2A331J	CHIP R 330 J 1/10W	
R10,11			RK73GB2A681J	CHIP R 680 J 1/10W		R92			RK73GB2A104J	CHIP R 100K J 1/10W	
R12			RK73GB2A102J	CHIP R 1.0K J 1/10W		R93			RK73GB2A105J	CHIP R 1.0M J 1/10W	
R13			RK73GB2A682J	CHIP R 6.8K J 1/10W		R94			RK73GB2A332J	CHIP R 3.3K J 1/10W	
R14			RK73FB2B100J	CHIP R 10 J 1/8W		R95			RK73GB2A102J	CHIP R 1.0K J 1/10W	
R15,16			RK73GB2A000J	CHIP R 0.0 J 1/10W		R96			RK73GB2A100J	CHIP R 10 J 1/10W	
R17			RK73GB2A181J	CHIP R 180 J 1/10W		R97			RK73GB2A101J	CHIP R 100 J 1/10W	
R19,20			RK73GB2A104J	CHIP R 100K J 1/10W		R98,99			RK73GB2A331J	CHIP R 330 J 1/10W	
R21			RK73GB2A684J	CHIP R 680K J 1/10W		R100			RK73GB2A000J	CHIP R 0.0 J 1/10W	
R22			RK73GB2A474J	CHIP R 470K J 1/10W		R101			RK73FB2B100J	CHIP R 10 J 1/8W	
R23			RK73GB2A000J	CHIP R 0.0 J 1/10W		R102			RK73GB2A101J	CHIP R 100 J 1/10W	
R24			RK73GB2A100J	CHIP R 10 J 1/10W		R103			RK73GB2A472J	CHIP R 4.7K J 1/10W	
R25			RK73GB2A561J	CHIP R 560 J 1/10W		R104,105			RK73GB2A123J	CHIP R 12K J 1/10W	
R26,27			RK73GB2A000J	CHIP R 0.0 J 1/10W		R106			RK73GB2A105J	CHIP R 1.0M J 1/10W	
R28			RK73GB2A100J	CHIP R 10 J 1/10W		R107,108			RK73GB2A103J	CHIP R 10K J 1/10W	
R29			RK73GB2A152J	CHIP R 1.5K J 1/10W		R110			RK73GB2A182J	CHIP R 1.8K J 1/10W	
R30			RK73GB2A684J	CHIP R 680K J 1/10W		R112			RK73GB2A102J	CHIP R 1.0K J 1/10W	
R31			RK73GB2A471J	CHIP R 470 J 1/10W		R114			RK73GB2A102J	CHIP R 1.0K J 1/10W	
R32			RK73GB2A104J	CHIP R 100K J 1/10W		R115			RK73FB2B220J	CHIP R 22 J 1/8W	
R33			RK73GB2A102J	CHIP R 1.0K J 1/10W		R116			RK73GB2A101J	CHIP R 100 J 1/10W	
R34			RK73GB2A471J	CHIP R 470 J 1/10W		R117,118			RK73FB2B220J	CHIP R 22 J 1/8W	
R36			RK73GB2A103J	CHIP R 10K J 1/10W		R119,120			RK73GB2A103J	CHIP R 10K J 1/10W	
R37			RK73GB2A123J	CHIP R 12K J 1/10W		R122			RK73GB2A101J	CHIP R 100 J 1/10W	
R38			RK73GB2A220J	CHIP R 22 J 1/10W		R123			RK73GB2A153J	CHIP R 15K J 1/10W	
R39			RK73GB2A000J	CHIP R 0.0 J 1/10W		R124			RK73GB2A392J	CHIP R 3.9K J 1/10W	
R40			RK73GB2A102J	CHIP R 1.0K J 1/10W		R125			RK73GB2A102J	CHIP R 1.0K J 1/10W	
R42-44			RK73GB2A000J	CHIP R 0.0 J 1/10W		R128			RK73GB2A101J	CHIP R 100 J 1/10W	
R45			RK73GB2A471J	CHIP R 470 J 1/10W		R129			RK73GB2A102J	CHIP R 1.0K J 1/10W	
R46			RK73GB2A330J	CHIP R 33 J 1/10W		R130,131			RK73FB2B100J	CHIP R 10 J 1/8W	
R47			RK73GB2A102J	CHIP R 1.0K J 1/10W		R132			RK73GB2A102J	CHIP R 1.0K J 1/10W	
R48			RK73FB2B271J	CHIP R 270 J 1/8W		R133			RK73GB2A123J	CHIP R 12K J 1/10W	
R50			RK73FB2B180J	CHIP R 18 J 1/8W		R134			RK73GB2A104J	CHIP R 100K J 1/10W	
R52			RK73GB2A100J	CHIP R 10 J 1/10W		R135,136			RK73GB2A332J	CHIP R 3.3K J 1/10W	
R53,54			RK73GB2A000J	CHIP R 0.0 J 1/10W		R137			RK73GB2A101J	CHIP R 100 J 1/10W	
R55			RK73FB2B271J	CHIP R 270 J 1/8W		R138,139			RK73GB2A682J	CHIP R 6.8K J 1/10W	
R56			RK73GB2A100J	CHIP R 10 J 1/10W		R140,141			RK73GB2A181J	CHIP R 180 J 1/10W	
R57			RK73GB2A470J	CHIP R 47 J 1/10W		R142			RK73FB2B100J	CHIP R 10 J 1/8W	
R60			RK73GB2A100J	CHIP R 10 J 1/10W		R145			RK73GB2A100J	CHIP R 10 J 1/10W	
R61			RK73GB2A470J	CHIP R 47 J 1/10W		R146			RK73GB2A101J	CHIP R 100 J 1/10W	
R62,63			RK73GB2A102J	CHIP R 1.0K J 1/10W		R147			RK73GB2A271J	CHIP R 270 J 1/10W	
R64			RK73GB2A000J	CHIP R 0.0 J 1/10W		R148			RK73GB2A561J	CHIP R 560 J 1/10W	
R65			RK73GB2A103J	CHIP R 10K J 1/10W		R149			RK73GB2A821J	CHIP R 820 J 1/10W	
R66,67			RN73GE1J391D	CHIP R 390 D 1/16W		R150			RK73FB2B101J	CHIP R 100 J 1/8W	
R68			RK73GB2A392J	CHIP R 3.9K J 1/10W		R151			RK73GB2A000J	CHIP R 0.0 J 1/10W	
R69-71			RK73GB2A102J	CHIP R 1.0K J 1/10W		R152			RK73GB2A102J	CHIP R 1.0K J 1/10W	
R72			RK73GB2A2R2J	CHIP R 2.2 J 1/10W		R153			RK73GB2A101J	CHIP R 100 J 1/10W	
R73			RK73GB2A104J	CHIP R 100K J 1/10W		R154			RK73GB2A000J	CHIP R 0.0 J 1/10W	
R75,76			RK73GB2A103J	CHIP R 10K J 1/10W		R155			RK73GB2A332J	CHIP R 3.3K J 1/10W	
R77,78			RK73FB2B470J	CHIP R 47 J 1/8W		R156			RK73GB2A680J	CHIP R 68 J 1/10W	
R79			RK73GB2A100J	CHIP R 10 J 1/10W		R157			RK73GB2A151J	CHIP R 150 J 1/10W	
R80			RK73GB2A271J	CHIP R 270 J 1/10W		R158			RK73GB2A101J	CHIP R 100 J 1/10W	
R81			RK73FB2B000J	CHIP R 0.0 J 1/8W		R159			RK73GB2A000J	CHIP R 0.0 J 1/10W	
						R160			RK73GB2A3R3J	CHIP R 3.3 J 1/10W	



## PARTS LIST

RX UNIT (X55-3102-72)

Ref. No.	Address	New parts	Parts No.	Description	Destination	Ref. No.	Address	New parts	Parts No.	Description	Destination
R161			RK73GB2A000J	CHIP R 0.0 J 1/10W		R244			RK73GB2A682J	CHIP R 6.8K J 1/10W	
R163			RK73GB2A102J	CHIP R 1.0K J 1/10W		R245			RK73GB2A473J	CHIP R 47K J 1/10W	
R164			RK73GB2A104J	CHIP R 100K J 1/10W		R248			RK73GB2A332J	CHIP R 3.3K J 1/10W	
R165,166			RK73GB2A273J	CHIP R 27K J 1/10W		R249			RK73GB2A222J	CHIP R 2.2K J 1/10W	
R167			RK73GB2A000J	CHIP R 0.0 J 1/10W		R250			RK73GB2A103J	CHIP R 10K J 1/10W	
R169			RK73GB2A103J	CHIP R 10K J 1/10W		R254,255			RK73GB2A000J	CHIP R 0.0 J 1/10W	
R171			RK73GB2A103J	CHIP R 10K J 1/10W		R256			RK73GB2A152J	CHIP R 1.5K J 1/10W	
R172			RK73GB2A100J	CHIP R 10 J 1/10W		R257,258			RK73GB2A000J	CHIP R 0.0 J 1/10W	
R173			RN73GE1J271D	CHIP R 270 D 1/16W		R259			RK73GB2A222J	CHIP R 2.2K J 1/10W	
R174,175			RK73GB2A153J	CHIP R 15K J 1/10W		R260			RK73GB2A103J	CHIP R 10K J 1/10W	
R176			RK73GB2A100J	CHIP R 10 J 1/10W		R261			RK73GB2A123J	CHIP R 12K J 1/10W	
R177			RK73GB2A470J	CHIP R 47 J 1/10W		R262			RK73GB2A472J	CHIP R 4.7K J 1/10W	
R178,179			RK73GB2A103J	CHIP R 10K J 1/10W		R263			RK73GB2A183J	CHIP R 18K J 1/10W	
R180			RK73GB2A100J	CHIP R 10 J 1/10W		R264			RK73GB2A152J	CHIP R 1.5K J 1/10W	
R181			RK73GB2A102J	CHIP R 1.0K J 1/10W		R265			RK73GB2A181J	CHIP R 180 J 1/10W	
R183			RK73GB2A102J	CHIP R 1.0K J 1/10W		R266			RK73GB2A332J	CHIP R 3.3K J 1/10W	
R184			RK73GB2A000J	CHIP R 0.0 J 1/10W		R267			RK73GB2A103J	CHIP R 10K J 1/10W	
R185			RK73GB2A100J	CHIP R 10 J 1/10W		R268			RK73GB2A154J	CHIP R 150K J 1/10W	
R186,187			RK73GB2A104J	CHIP R 100K J 1/10W		R269			RK73GB2A470J	CHIP R 47 J 1/10W	
R189,190			RK73FB2B101J	CHIP R 100 J 1/8W		R270,271			RK73GB2A103J	CHIP R 10K J 1/10W	
R191,192			RK73FB2B271J	CHIP R 270 J 1/8W		R272			RK73GB2A104J	CHIP R 100K J 1/10W	
R193			RK73GB2A102J	CHIP R 1.0K J 1/10W		R273			RK73GB2A152J	CHIP R 1.5K J 1/10W	
R194			RK73GB2A472J	CHIP R 4.7K J 1/10W		R274			RK73GB2A103J	CHIP R 10K J 1/10W	
R195			RK73GB2A181J	CHIP R 180 J 1/10W		R275			RK73GB2A223J	CHIP R 22K J 1/10W	
R196,197			RK73FB2B100J	CHIP R 10 J 1/8W		R276			RK73GB2A183J	CHIP R 18K J 1/10W	
R198,199			RK73GB2A102J	CHIP R 1.0K J 1/10W		R277			RK73GB2A103J	CHIP R 10K J 1/10W	
R200			RK73GB2A682J	CHIP R 6.8K J 1/10W		R278,279			RK73GB2A152J	CHIP R 1.5K J 1/10W	
R201			RK73GB2A330J	CHIP R 33 J 1/10W		R280,281			RK73GB2A103J	CHIP R 10K J 1/10W	
R202			RK73GB2A2R2J	CHIP R 2.2 J 1/10W		R284			RK73GB2A471J	CHIP R 470 J 1/10W	
R203			RK73GB2A104J	CHIP R 100K J 1/10W		R285			RK73GB2A334J	CHIP R 330K J 1/10W	
R204			RK73GB2A332J	CHIP R 3.3K J 1/10W		R286			RK73GB2A183J	CHIP R 18K J 1/10W	
R205			RK73GB2A682J	CHIP R 6.8K J 1/10W		R287			RK73GB2A273J	CHIP R 27K J 1/10W	
R206			RK73GB2A152J	CHIP R 1.5K J 1/10W		R288			RK73GB2A560J	CHIP R 56 J 1/10W	
R207,208			RK73GB2A470J	CHIP R 47 J 1/10W		R290			RK73GB2A332J	CHIP R 3.3K J 1/10W	
R209			RK73GB2A101J	CHIP R 100 J 1/10W		R291			RK73GB2A122J	CHIP R 1.2K J 1/10W	
R210			RK73GB2A100J	CHIP R 10 J 1/10W		R292			RK73GB2A000J	CHIP R 0.0 J 1/10W	
R211			RK73GB2A104J	CHIP R 100K J 1/10W		R293			RK73GB2A183J	CHIP R 18K J 1/10W	
R212			RK73GB2A100J	CHIP R 10 J 1/10W		R294			RK73GB2A223J	CHIP R 22K J 1/10W	
R213,214			RK73GB2A563J	CHIP R 56K J 1/10W		R295			RK73GB2A104J	CHIP R 100K J 1/10W	
R215			RK73GB2A181J	CHIP R 180 J 1/10W		R296-298			RK73GB2A473J	CHIP R 47K J 1/10W	
R217			RK73GB2A104J	CHIP R 100K J 1/10W		R300			RK73GB2A103J	CHIP R 10K J 1/10W	
R218,219			RK73GB2A180J	CHIP R 18 J 1/10W		R306			RK73GB2A473J	CHIP R 47K J 1/10W	
R220			RK73GB2A102J	CHIP R 1.0K J 1/10W		R307-310			RK73GB2A000J	CHIP R 0.0 J 1/10W	
R221,222			RK73GB2A471J	CHIP R 470 J 1/10W		R311			RK73GB2A474J	CHIP R 470K J 1/10W	
R223			RK73GB2A180J	CHIP R 18 J 1/10W		R317-319			RK73GB2A100J	CHIP R 10 J 1/10W	
R224			RK73GB2A100J	CHIP R 10 J 1/10W		R321			RK73GB2A104J	CHIP R 100K J 1/10W	
R225			RK73GB2A180J	CHIP R 18 J 1/10W		R323			RK73GB2A000J	CHIP R 0.0 J 1/10W	
R226			RK73GB2A101J	CHIP R 100 J 1/10W		R324,325			RK73GB2A104J	CHIP R 100K J 1/10W	
R229			RK73GB2A101J	CHIP R 100 J 1/10W		R326			RK73GB2A100J	CHIP R 10 J 1/10W	
R230			RK73GB2A100J	CHIP R 10 J 1/10W		R328			RK73GB2A000J	CHIP R 0.0 J 1/10W	
R231			RK73GB2A680J	CHIP R 68 J 1/10W		R330			RK73GB2A104J	CHIP R 100K J 1/10W	
R232			RK73GB2A100J	CHIP R 10 J 1/10W		R332			RK73GB2A101J	CHIP R 100 J 1/10W	
R233			RK73GB2A000J	CHIP R 0.0 J 1/10W		R333			RK73GB2A104J	CHIP R 100K J 1/10W	
R234			RK73GB2A101J	CHIP R 100 J 1/10W		R334			RK73GB2A101J	CHIP R 100 J 1/10W	
R236,237			RK73GB2A180J	CHIP R 18 J 1/10W		R335			RK73GB2A104J	CHIP R 100K J 1/10W	
R238			RK73GB2A181J	CHIP R 180 J 1/10W		R337			RK73GB2A102J	CHIP R 1.0K J 1/10W	
R239			RK73GB2A100J	CHIP R 10 J 1/10W		R338			RK73GB2A472J	CHIP R 4.7K J 1/10W	
R240			RK73GB2A471J	CHIP R 470 J 1/10W		R340-342			RK73GB2A102J	CHIP R 1.0K J 1/10W	
R241			RK73GB2A103J	CHIP R 10K J 1/10W		R343			RK73GB2A104J	CHIP R 100K J 1/10W	
R242,243			RK73GB2A470J	CHIP R 47 J 1/10W		R344			RK73GB2A473J	CHIP R 47K J 1/10W	

## PARTS LIST

### RX UNIT (X55-3102-72)

Ref. No.	Address	New parts	Parts No.	Description	Destination	Ref. No.	Address	New parts	Parts No.	Description	Destination
R345,346			RK73GB2A472J	CHIP R 4.7K J 1/10W		IC6			LMC7101BIM5	MOS-IC	
R347,348			RK73GB2A101J	CHIP R 100 J 1/10W		IC7			AD9835BRUZ	MOS-IC	
R349			RK73GB2A470J	CHIP R 47 J 1/10W		IC8		*	NJU6368PF1	MOS-IC	
R350,351			RK73GB2A221J	CHIP R 220 J 1/10W		IC9			UPB1509GV	BI-POLAR IC	
R352			RK73GB2A473J	CHIP R 47K J 1/10W		IC10			TK11230CMCL-G	BI-POLAR IC	
R353			RK73GB2A470J	CHIP R 47 J 1/10W		IC11			ADF4111BCP7	MOS-IC	
R357			RK73GB2A471J	CHIP R 470 J 1/10W		IC12			TA31137FNG	MOS-IC	
R358			RK73GB2A100J	CHIP R 10 J 1/10W		IC13			AD607Z	BI-POLAR IC	
R359			RK73GB2A221J	CHIP R 220 J 1/10W		IC14			AD8051ART	ANALOGUE IC	
R360			RK73GB2A682J	CHIP R 6.8K J 1/10W		IC15,16			NJM78L05UA-ZB	BI-POLAR IC	
R361			RK73GB2A332J	CHIP R 3.3K J 1/10W		IC17-19			NJM78M05DL1AZB	ANALOGUE IC	
R362			RK73GB2A101J	CHIP R 100 J 1/10W		IC20			NJM4558E-ZB	ANALOGUE IC	
R363			RK73GB2A100J	CHIP R 10 J 1/10W		IC22			XC6204B332M	MOS-IC	
R364			RK73GB2A470J	CHIP R 47 J 1/10W		IC23			BH2220FVM	ANALOGUE IC	
R366,367			RK73GB2A000J	CHIP R 0.0 J 1/10W		IC24,25	2D		NJM7808FA-ZB	BI-POLAR IC	
R368-370			RK73GB2A103J	CHIP R 10K J 1/10W		IC26,27			NJM2386ADL3-09	ANALOGUE IC	
R371,372			RK73GB2A000J	CHIP R 0.0 J 1/10W		IC28			AD1582	ANALOGUE IC	
R373			RK73GB2A103J	CHIP R 10K J 1/10W		IC29			NJM2732V	BI-POLAR IC	
R375,376			RK73GB2A105J	CHIP R 1.0M J 1/10W		IC30			AD7908BRU	MOS-IC	
R377			RK73GB2A000J	CHIP R 0.0 J 1/10W		IC31			S24CS02AFJTBG	ROM IC	
R379			RK73GB2A101J	CHIP R 100 J 1/10W		IC32			NJM2732V	BI-POLAR IC	
R380			RK73GB2A104J	CHIP R 100K J 1/10W		IC33			LMC7101BIM5	MOS-IC	
R381			RK73GB2A223J	CHIP R 22K J 1/10W		IC35			LM50BIM3/NOPB	MOS-IC	
R382-384			RK73GB2A104J	CHIP R 100K J 1/10W		Q1		*	2SC5336-AZ	TRANSISTOR	
R385			RK73GB2A101J	CHIP R 100 J 1/10W		Q2			2SC4116(BL)F	TRANSISTOR	
R388			RK73GB2A000J	CHIP R 0.0 J 1/10W		Q3			2SC4617(R)	TRANSISTOR	
R390			RK73GB2A471J	CHIP R 470 J 1/10W		Q4			2SC4116(BL)F	TRANSISTOR	
R391,392			RK73GB2A000J	CHIP R 0.0 J 1/10W		Q5			2SC4617(R)	TRANSISTOR	
R393			RK73GB2A103J	CHIP R 10K J 1/10W		Q6			2SC4116(BL)F	TRANSISTOR	
R394			RK73GB2A000J	CHIP R 0.0 J 1/10W		Q7,8			2SK508NV(K53)	FET	
R396			RK73GB2A101J	CHIP R 100 J 1/10W		Q9-11			2SC4116(BL)F	TRANSISTOR	
R400,401			RK73GB2A000J	CHIP R 0.0 J 1/10W		Q12			2SC4617(R)	TRANSISTOR	
R403			RK73GB2A000J	CHIP R 0.0 J 1/10W		Q13		*	2SA1832F	TRANSISTOR	
R405			RK73GB2A153J	CHIP R 15K J 1/10W		Q14,15			SSM3K15TE(F)	FET	
R406			RK73GB2A682J	CHIP R 6.8K J 1/10W		Q16,17			2SC3356-A(R24)	TRANSISTOR	
R407			RK73GB2A000J	CHIP R 0.0 J 1/10W		Q18-20			RD01MUS1-T113	FET	
R410			RK73GB2A000J	CHIP R 0.0 J 1/10W		Q21			2SC4725	TRANSISTOR	
R417			RK73GB2A000J	CHIP R 0.0 J 1/10W		Q22			2SC4617(R)	TRANSISTOR	
R422-425			RK73GB2A000J	CHIP R 0.0 J 1/10W		Q23			2SC3356-A(R24)	TRANSISTOR	
R430,431			RN73GE1J331D	CHIP R 330 D 1/16W		Q24			2SK508NV(K52)	FET	
R432			RK73GB2A103J	CHIP R 10K J 1/10W		Q25			SSM3J01F	FET	
R435			RK73GB2A473J	CHIP R 47K J 1/10W		Q26			SSM3K15TE(F)	FET	
R436			RK73GB2A472J	CHIP R 4.7K J 1/10W		Q27			2SC4116(BL)F	TRANSISTOR	
R437			RK73GB2A000J	CHIP R 0.0 J 1/10W		Q28,29			3SK317-E	FET	
R454			RK73GB2A000J	CHIP R 0.0 J 1/10W		Q30			2SC4617(R)	TRANSISTOR	
R455			RK73GB2A104J	CHIP R 100K J 1/10W		Q31			SSM3K15TE(F)	FET	
R459			RK73GB2A000J	CHIP R 0.0 J 1/10W		Q32			SSM3J01F	FET	
R462			RK73GB2A000J	CHIP R 0.0 J 1/10W		Q33			2SC4725	TRANSISTOR	
D1,2			HSC119	DIODE		Q34		*	2SA1832F	TRANSISTOR	
D3-6			1SV283F	VARIABLE CAPACITANCE DIODE		Q35,36			2SC4725	TRANSISTOR	
D9,10			JDP4P02U	DIODE		Q37			SSM3K15TE(F)	FET	
D11			KV1470-G	VARIABLE CAPACITANCE DIODE		Q38			2SC4725	TRANSISTOR	
D12			1SV283F	VARIABLE CAPACITANCE DIODE		Q39			2SC4617(R)	TRANSISTOR	
D13,14			JDP4P02U	DIODE		Q40			2SC4617(S)	TRANSISTOR	
D15,16			DAN235E	DIODE		Q50,51			SSM3K15TE(F)	FET	
D17,18			MA3J742	DIODE		Q52			2SJ484	FET	
D19,20			DAN235E	DIODE		Q53			2SC4725	TRANSISTOR	
IC4			TA75S01F-F	MOS-IC		Q56			SSM3K15TE(F)	FET	
IC5			ADF4111BCP7	MOS-IC		Q57			DTA144EEB	DIGITAL TRANSISTOR	
						Q58-61			SSM3K15TE(F)	FET	



## PARTS LIST

RX UNIT (X55-3102-72)  
TX UNIT (X56-3120-12)

Ref. No.	Address	New parts	Parts No.	Description	Destination	Ref. No.	Address	New parts	Parts No.	Description	Destination
TH2,3			157-103-53007	THERMISTOR		C172			CK73GB1H471K	CHIP C 470PF	K
A1			W02-1940-05	DBM		C173,174			CC73GCH1H471J	CHIP C 470PF	J
-			212-1514-05	INSULATING TUBE		C175			CC73GCH1H070D	CHIP C 7.0PF	D
<b>TX UNIT (X56-3120-12)</b>						C176			CC73GCH1H471J	CHIP C 470PF	J
D202			B30-2230-05	LED (YELLOW)		C177-180			CK73GB1H104K	CHIP C 0.10UF	K
D301			B30-2230-05	LED (YELLOW)		C181			CC73GCH1H471J	CHIP C 470PF	J
D920-924			B30-2265-05	LED (RED/GREEN)		C182			CC73GCH1H120G	CHIP C 12PF	G
D925-932			B30-2171-05	LED (ORANGE)		C183			CC73GCH1H220J	CHIP C 22PF	J
C101			CS77CA1ER47M	CHIP TNTL 0.47UF 25WV		C186			CC73GCH1H120J	CHIP C 12PF	J
C102			CK73GB1E105K	CHIP C 1.0UF K		C187			C93-0912-05	CHIP C 100UF	M
C103-105			CC73GCH1H471J	CHIP C 470PF J		C188			CC73GCH1H471J	CHIP C 470PF	J
C106,107			CK73GB1H103K	CHIP C 0.010UF K		C189			CC73GCH1H090B	CHIP C 9.0PF	B
C108			CC73GCH1H471J	CHIP C 470PF J		C190			CC73GCH1H0R5B	CHIP C 0.5PF	B
C109			CK73GB1H104K	CHIP C 0.10UF K		C191			CC73GCH1H020B	CHIP C 2.0PF	B
C110			CC73GCH1H471J	CHIP C 470PF J		C192			CC73GCH1H471J	CHIP C 470PF	J
C111,112			CK73GB1H104K	CHIP C 0.10UF K		C193,194			CC73GCH1H120G	CHIP C 12PF	G
C113			CC73GCH1H471J	CHIP C 470PF J		C195			CC73GCH1H0R5B	CHIP C 0.5PF	B
C114			CK73GB1H104K	CHIP C 0.10UF K		C196-198			CC73GCH1H471J	CHIP C 470PF	J
C115-117			CC73GCH1H471J	CHIP C 470PF J		C201			CC73GCH1H471J	CHIP C 470PF	J
C120			CK73GB1H103K	CHIP C 0.010UF K		C202			CC73GCH1H070D	CHIP C 7.0PF	D
C122			CC73GCH1H471J	CHIP C 470PF J		C203,204			CC73GCH1H471J	CHIP C 470PF	J
C123			CS77CA1VR22M	CHIP TNTL 0.22UF 35WV		C205			CK73GB1H103K	CHIP C 0.010UF	K
C124			CS77CC1C330M	CHIP TNTL 33UF 16WV		C206			CC73GCH1H471J	CHIP C 470PF	J
C126			CC73GCH1H471J	CHIP C 470PF J		C207			CC73GCH1H070D	CHIP C 7.0PF	D
C132			CC73GCH1H080B	CHIP C 8.0PF B		C208,209			CC73GCH1H471J	CHIP C 470PF	J
C133			CC73GCH1H100C	CHIP C 10PF C		C210,211			CC73GCH1H060D	CHIP C 6.0PF	D
C134			CC73GCH1H270J	CHIP C 27PF J		C212-215			CC73GCH1H471J	CHIP C 470PF	J
C135			CC73GCH1H471J	CHIP C 470PF J		C216			CK73GB1H103K	CHIP C 0.010UF	K
C136			CC73GCH1H080B	CHIP C 8.0PF B		C217			CC73GCH1H100D	CHIP C 10PF	D
C137			CK73GB1H103K	CHIP C 0.010UF K		C218			CC73GCH1H120J	CHIP C 12PF	J
C138			CC73GCH1H0R5B	CHIP C 0.5PF B		C219			CC73GCH1H471J	CHIP C 470PF	J
C139			CC73GCH1H020B	CHIP C 2.0PF B		C220			CK73GB1H104K	CHIP C 0.10UF	K
C140,141			CC73GCH1H471J	CHIP C 470PF J		C221			CC73GCH1H030C	CHIP C 3.0PF	C
C142			CC73GCH1H120J	CHIP C 12PF J		C223			CC73GCH1H471J	CHIP C 470PF	J
C143			CC73GCH1H100D	CHIP C 10PF D		C224			CK73GB1H473K	CHIP C 0.047UF	K
C145			CC73GCH1H120J	CHIP C 12PF J		C225,226			CC73GCH1H471J	CHIP C 470PF	J
C146			CC73GCH1H471J	CHIP C 470PF J		C227			CK73GB1H103K	CHIP C 0.010UF	K
C147			CC73GCH1H0R5B	CHIP C 0.5PF B		C228			CC73GCH1H471J	CHIP C 470PF	J
C148			CC73GCH1H150J	CHIP C 15PF J		C230			CC73GCH1H471J	CHIP C 470PF	J
C149			CK73GB1H103K	CHIP C 0.010UF K		C231			CK73GB1H103K	CHIP C 0.010UF	K
C151			CE32CL1V100M	CHIP EL 10UF 35WV		C233			CC73GCH1H010C	CHIP C 1.0PF	C
C152			CC73GCH1H471J	CHIP C 470PF J		C234			CC73GCH1H471J	CHIP C 470PF	J
C153			CC73GCH1H100D	CHIP C 10PF D		C235			CK73GB1H103K	CHIP C 0.010UF	K
C154			CS77CC1C330M	CHIP TNTL 33UF 16WV		C237			CC73GCH1H471J	CHIP C 470PF	J
C156,157			CC73GCH1H471J	CHIP C 470PF J		C240			CC73GCH1H221J	CHIP C 220PF	J
C158			CS77CC1C330M	CHIP TNTL 33UF 16WV		C241			CC73GCH1H820J	CHIP C 82PF	J
C160			CC73GCH1H471J	CHIP C 470PF J		C242			CC73GCH1H330J	CHIP C 33PF	J
C161			CE32BM1E470M	CHIP EL 47UF 25WV		C243,244			CC73GCH1H471J	CHIP C 470PF	J
C162,163			CC73GCH1H471J	CHIP C 470PF J		C245			CC73GCH1H470J	CHIP C 47PF	J
C164			CC73GCH1H070D	CHIP C 7.0PF D		C246,247			CC73GCH1H471J	CHIP C 470PF	J
C166			CC73GCH1H060D	CHIP C 6.0PF D		C248			CC73GCH1H151J	CHIP C 150PF	J
C167			CC73GCH1H070D	CHIP C 7.0PF D		C249			CE32CL1V100M	CHIP EL 10UF 35WV	
C168			CC73GCH1H030C	CHIP C 3.0PF C		C250			CK73GB1H104K	CHIP C 0.10UF	K
C169,170			CC73GCH1H471J	CHIP C 470PF J		C251,252			CK73GB1H103K	CHIP C 0.010UF	K
C171			CK73GB1H103K	CHIP C 0.010UF K		C253			CE32CL1V100M	CHIP EL 10UF 35WV	
						C254			CK73GB1H104K	CHIP C 0.10UF	K
						C255,256			CK73GB1H103K	CHIP C 0.010UF	K
						C257-260			CK73GB1H104K	CHIP C 0.10UF	K
						C263			CC73GCH1H390J	CHIP C 39PF	J
						C265			CC73GCH1H680J	CHIP C 68PF	J

## PARTS LIST

### TX UNIT (X56-3120-12)

Ref. No.	Address	New parts	Parts No.	Description	Destination	Ref. No.	Address	New parts	Parts No.	Description	Destination
C267			CC73GCH1H390J	CHIP C 39PF J		C358			CK73GB1H104K	CHIP C 0.10UF K	
C269-272			CK73GB1H104K	CHIP C 0.10UF K		C359			CC73GCH1H100D	CHIP C 10PF D	
C275			CC73GCH1H471J	CHIP C 470PF J		C360			CK73GB1H103K	CHIP C 0.010UF K	
C276			CC73GCH1H271J	CHIP C 270PF J		C361			CK73GB1H104K	CHIP C 0.10UF K	
C277			CC73GCH1H471J	CHIP C 470PF J		C362			CC73GCH1H471J	CHIP C 470PF J	
C278			CC73GCH1H391J	CHIP C 390PF J		C363,364			CK73GB1H103K	CHIP C 0.010UF K	
C279			CC73GCH1H471J	CHIP C 470PF J		C365			CC73GCH1H471J	CHIP C 470PF J	
C280			CC73GCH1H271J	CHIP C 270PF J		C366			CC73GCH1H100D	CHIP C 10PF D	
C281			CC73GCH1H471J	CHIP C 470PF J		C367			CK73GB1H103K	CHIP C 0.010UF K	
C282-285			CK73GB1H104K	CHIP C 0.10UF K		C369,370			CK73GB1H103K	CHIP C 0.010UF K	
C286			CK73GB1H103K	CHIP C 0.010UF K		C372			CC73GCH1H180J	CHIP C 18PF J	
C287			CK73GB1H104K	CHIP C 0.10UF K		C373			CC73GCH1H470J	CHIP C 47PF J	
C301			CS77CA1C2R2M	CHIP TNL 2.2UF 16WV		C375			CK73GB1H103K	CHIP C 0.010UF K	
C302			CC73GCH1H100D	CHIP C 10PF D		C376			CC73GCH1H471J	CHIP C 470PF J	
C303			CK73GB1H103K	CHIP C 0.010UF K		C378			CK73FB1C105K	CHIP C 1.0UF K	
C304			CC73GCH1H331J	CHIP C 330PF J		C379			CK73GB1H103K	CHIP C 0.010UF K	
C305			CC73GCH1H180J	CHIP C 18PF J		C381			CK73GB1H103K	CHIP C 0.010UF K	
C306			CK73FB0J106K	CHIP C 10UF K		C382			CC73GCH1H221J	CHIP C 220PF J	
C307			CK73GB1H104K	CHIP C 0.10UF K		C383			CC73GCH1H331J	CHIP C 330PF J	
C308			CC73GCH1H471J	CHIP C 470PF J		C384			CC73GCH1H181J	CHIP C 180PF J	
C309			CC73GCH1H331J	CHIP C 330PF J		C386			CE32CL1V100M	CHIP EL 10UF 35WV	
C310			CK73FB0J106K	CHIP C 10UF K		C387			CK73GB1H104K	CHIP C 0.10UF K	
C311			C93-0912-05	CHIP C 100UF M		C388			CC73GCH1H471J	CHIP C 470PF J	
C312			CK73GB1H103K	CHIP C 0.010UF K		C389			CK73GB1H102K	CHIP C 1000PF K	
C313			CC73GCH1H121J	CHIP C 120PF J		C390			CK73GB1H222K	CHIP C 2200PF K	
C314,315			CK73GB1H103K	CHIP C 0.010UF K		C391			C93-0912-05	CHIP C 100UF M	
C316			CC73GCH1H100D	CHIP C 10PF D		C392,393			CC73GCH1H100D	CHIP C 10PF D	
C317			CK73GB1H104K	CHIP C 0.10UF K		C401			CK73GB1H103K	CHIP C 0.010UF K	
C318			CE32BM1E470M	CHIP EL 47UF 25WV		C402,403			CK73GB1H104K	CHIP C 0.10UF K	
C319			CK73GB1H104K	CHIP C 0.10UF K		C404			CK73GB1H103K	CHIP C 0.010UF K	
C320			CK73GB1H103K	CHIP C 0.010UF K		C405			CC73GCH1H471J	CHIP C 470PF J	
C321			CC73GCH1H471J	CHIP C 470PF J		C406-412			CK73GB1H103K	CHIP C 0.010UF K	
C323-326			CK73GB1H103K	CHIP C 0.010UF K		C413			CC73GCH1H471J	CHIP C 470PF J	
C327			CC73GCH1H181J	CHIP C 180PF J		C414-416			CK73GB1H103K	CHIP C 0.010UF K	
C328,329			C93-0912-05	CHIP C 100UF M		C419			CK73FB0J106K	CHIP C 10UF K	
C330			CC73GCH1H470J	CHIP C 47PF J		C420			CK73GB1H103K	CHIP C 0.010UF K	
C331			CK73GB1H104K	CHIP C 0.10UF K		C422			CK73GB1H103K	CHIP C 0.010UF K	
C332			CC73GCH1H331J	CHIP C 330PF J		C423			CE32BM1E470M	CHIP EL 47UF 25WV	
C333			CS77CC1C100M	CHIP TNL 10UF 16WV		C425			CC73GCH1H181J	CHIP C 180PF J	
C334			CK73GB1H103K	CHIP C 0.010UF K		C427			CC73GCH1H470J	CHIP C 47PF J	
C335			CK73GB1H102K	CHIP C 1000PF K		C429			CC73GCH1H331J	CHIP C 330PF J	
C336			CC73GCH1H180J	CHIP C 18PF J		C430			CC73GCH1H180J	CHIP C 18PF J	
C337			CK73GB1H103K	CHIP C 0.010UF K		C433			CC73GCH1H221J	CHIP C 220PF J	
C338			CS77CB21A470M	CHIP TNL 47UF 10WV		C435			CK73GB1H104K	CHIP C 0.10UF K	
C339			CC73GCH1H221J	CHIP C 220PF J		C436			CS77BA1E010M	CHIP TNL 1.0UF 25WV	
C340			CK73GB1H103K	CHIP C 0.010UF K		C437			CK73GB1H103K	CHIP C 0.010UF K	
C341			CK73GB1H104K	CHIP C 0.10UF K		C439-443			CK73GB1H103K	CHIP C 0.010UF K	
C342			CS77CB21A470M	CHIP TNL 47UF 10WV		C445			CS77CA1V0R1M	CHIP TNL 0.1UF 35WV	
C343,344			CK73GB1H103K	CHIP C 0.010UF K		C446			CK73FB1E473K	CHIP C 0.047UF K	
C345			CK73GB1H104K	CHIP C 0.10UF K		C447			CK73FB0J106K	CHIP C 10UF K	
C346,347			CK73GB1H103K	CHIP C 0.010UF K		C448			CK73GB1H104K	CHIP C 0.10UF K	
C348			CC73GCH1H221J	CHIP C 220PF J		C449			CK73GB1H103K	CHIP C 0.010UF K	
C349,350			CC73GCH1H100D	CHIP C 10PF D		C451			CK73GB1H104K	CHIP C 0.10UF K	
C351			CS77CC1C100M	CHIP TNL 10UF 16WV		C452			CK73FB0J106K	CHIP C 10UF K	
C352			CC73GCH1H180J	CHIP C 18PF J		C453			CC73GCH1H181J	CHIP C 180PF J	
C353			CK73GB1H103K	CHIP C 0.010UF K		C454			CC73GCH1H470J	CHIP C 47PF J	
C354			CC73GCH1H331J	CHIP C 330PF J		C455			CK73GB1H103K	CHIP C 0.010UF K	
C355			CC73GCH1H470J	CHIP C 47PF J		C456			CC73GCH1H331J	CHIP C 330PF J	
C356			CK73GB1H103K	CHIP C 0.010UF K		C457			CC73GCH1H181J	CHIP C 180PF J	
C357			CC73GCH1H181J	CHIP C 180PF J		C458			CC73GCH1H470J	CHIP C 47PF J	

## PARTS LIST

TX UNIT (X56-3120-12)

Ref. No.	Address	New parts	Parts No.	Description	Desti-nation	Ref. No.	Address	New parts	Parts No.	Description	Desti-nation
C459			CC73GCH1H180J	CHIP C 18PF J		C610			CK73GB1H104K	CHIP C 0.10UF K	
C460			CC73GCH1H331J	CHIP C 330PF J		C612,613			CK73GB1H104K	CHIP C 0.10UF K	
C461			CC73GCH1H221J	CHIP C 220PF J		C614			CC73GCH1H100D	CHIP C 10PF D	
C462			CC73GCH1H180J	CHIP C 18PF J		C616			CC73GCH1H270J	CHIP C 27PF J	
C463			CK73GB1H104K	CHIP C 0.10UF K		C619			CC73GCH1H100D	CHIP C 10PF D	
C464,465			CK73GB1H103K	CHIP C 0.010UF K		C620-623			CK73GB1H104K	CHIP C 0.10UF K	
C466			CC73GCH1H221J	CHIP C 220PF J		C624-627			CC73GCH1H560J	CHIP C 56PF J	
C467			CK73FB1C105K	CHIP C 1.0UF K		C628-631			CK73GB1H104K	CHIP C 0.10UF K	
C468,469			CK73GB1H103K	CHIP C 0.010UF K		C632-634			CK73GB1H103K	CHIP C 0.010UF K	
C470			CK73GB1H104K	CHIP C 0.10UF K		C635,636			CK73GB1H104K	CHIP C 0.10UF K	
C471-482			CK73GB1H103K	CHIP C 0.010UF K		C637			CK73GB1H103K	CHIP C 0.010UF K	
C483-486			CK73GB1H104K	CHIP C 0.10UF K		C638			CC73GCH1H470J	CHIP C 47PF J	
C487			CK73GB1H103K	CHIP C 0.010UF K		C639			CC73GCH1H180J	CHIP C 18PF J	
C488-490			CK73GB1H104K	CHIP C 0.10UF K		C640			CC73GCH1H181J	CHIP C 180PF J	
C491			CC73GCH1H470J	CHIP C 47PF J		C641			CC73GCH1H331J	CHIP C 330PF J	
C492-495			CK73GB1H104K	CHIP C 0.10UF K		C642			CC73GCH1H221J	CHIP C 220PF J	
C496			CC73GCH1H221J	CHIP C 220PF J		C643			CC73GCH1H471J	CHIP C 470PF J	
C497			CK73GB1H104K	CHIP C 0.10UF K		C645			CC73GCH1H471J	CHIP C 470PF J	
C498			CC73GCH1H121J	CHIP C 120PF J		C656,657			CK73GB1H103K	CHIP C 0.010UF K	
C499			CK73GB1H104K	CHIP C 0.10UF K		C658			CK73GB1H104K	CHIP C 0.10UF K	
C500			CC73GCH1H471J	CHIP C 470PF J		C659,660			CK73GB1H103K	CHIP C 0.010UF K	
C501,502			CK73GB1H104K	CHIP C 0.10UF K		C661			CK73FB0J106K	CHIP C 10UF K	
C503			CC73GCH1H470J	CHIP C 47PF J		C662,663			CK73GB1H104K	CHIP C 0.10UF K	
C504			CC73GCH1H010C	CHIP C 1.0PF C		C703			CK73GB1H104K	CHIP C 0.10UF K	
C505,506			CK73GB1H104K	CHIP C 0.10UF K		C704			CK73FB0J106K	CHIP C 10UF K	
C507,508			CC73GCH1H331J	CHIP C 330PF J		C707			CK73GB1H102K	CHIP C 1000PF K	
C509,510			CK73GB1H104K	CHIP C 0.10UF K		C708			CK73GB1H104K	CHIP C 0.10UF K	
C511			CC73GCH1H470J	CHIP C 47PF J		C709			CE32CL1V100M	CHIP EL 10UF 35WV	
C512			CC73GCH1H471J	CHIP C 470PF J		C710			CK73GB1H104K	CHIP C 0.10UF K	
C513			CC73GCH1H010C	CHIP C 1.0PF C		C711			CK73GB1H103K	CHIP C 0.010UF K	
C514			CC73GCH1H121J	CHIP C 120PF J		C712,713			CC73GCH1H471J	CHIP C 470PF J	
C515			CC73GCH1H030C	CHIP C 3.0PF C		C714			CK73GB1H103K	CHIP C 0.010UF K	
C516,517			CK73GB1H104K	CHIP C 0.10UF K		C715			CE32CL1V100M	CHIP EL 10UF 35WV	
C519			CK73GB1H104K	CHIP C 0.10UF K		C716			CK73GB1H103K	CHIP C 0.010UF K	
C520			CC73GCH1H221J	CHIP C 220PF J		C717,718			CC73GCH1H471J	CHIP C 470PF J	
C521-527			CK73GB1H104K	CHIP C 0.10UF K		C719			CK73GB1H103K	CHIP C 0.010UF K	
C529-532			CK73GB1H104K	CHIP C 0.10UF K		C720,721			CE32CL1V100M	CHIP EL 10UF 35WV	
C533			CC73GCH1H471J	CHIP C 470PF J		C722			CK73GB1H103K	CHIP C 0.010UF K	
C534-537			CK73GB1H104K	CHIP C 0.10UF K		C723,724			CC73GCH1H471J	CHIP C 470PF J	
C538			CC73GCH1H471J	CHIP C 470PF J		C725			CK73GB1H103K	CHIP C 0.010UF K	
C539			CK73GB1H104K	CHIP C 0.10UF K		C801-803			CK73GB1H104K	CHIP C 0.10UF K	
C541,542			CC73GCH1H100D	CHIP C 10PF D		C804			CC73GCH1H471J	CHIP C 470PF J	
C543-547			CK73GB1H104K	CHIP C 0.10UF K		C805			CK73GB1H104K	CHIP C 0.10UF K	
C548			CC73GCH1H471J	CHIP C 470PF J		C806			CE32CL1V100M	CHIP EL 10UF 35WV	
C549-552			CK73GB1H104K	CHIP C 0.10UF K		C807			CK73FB1C105K	CHIP C 1.0UF K	
C554-556			CK73GB1H104K	CHIP C 0.10UF K		C808,809			CK73GB1H104K	CHIP C 0.10UF K	
C557			CC73GCH1H030C	CHIP C 3.0PF C		C810			CC73GCH1H471J	CHIP C 470PF J	
C558,559			CK73GB1H104K	CHIP C 0.10UF K		C811			CK73GB1H104K	CHIP C 0.10UF K	
C562			CK73GB1H104K	CHIP C 0.10UF K		C812			CK73GB1H103K	CHIP C 0.010UF K	
C563			CC73GCH1H121J	CHIP C 120PF J		C813			CC73GCH1H471J	CHIP C 470PF J	
C564			CC73GCH1H470J	CHIP C 47PF J		C814			CK73GB1H104K	CHIP C 0.10UF K	
C565			CK73GB1H104K	CHIP C 0.10UF K		C816			CE32CL1V100M	CHIP EL 10UF 35WV	
C568			CC73GCH1H221J	CHIP C 220PF J		C817			CK73GB1H103K	CHIP C 0.010UF K	
C569			CC73GCH1H471J	CHIP C 470PF J		C818			CE32CL1V100M	CHIP EL 10UF 35WV	
C570			CC73GCH1H010C	CHIP C 1.0PF C		C819			CC73GCH1H471J	CHIP C 470PF J	
C571			CC73GCH1H331J	CHIP C 330PF J		C820,821			CK73GB1H104K	CHIP C 0.10UF K	
C573,574			CC73GCH1H331J	CHIP C 330PF J		C822			CK73GB1H103K	CHIP C 0.010UF K	
C575,576			CC73GCH1H180J	CHIP C 18PF J		C823,824			CC73GCH1H471J	CHIP C 470PF J	
C577,578			CC73GCH1H331J	CHIP C 330PF J		C825			CK73GB1H103K	CHIP C 0.010UF K	
C601-605			CK73GB1H104K	CHIP C 0.10UF K		C826			CC73GCH1H471J	CHIP C 470PF J	

# NXR-800

## PARTS LIST

### TX UNIT (X56-3120-12)

Ref. No.	Address	New parts	Parts No.	Description	Destination	Ref. No.	Address	New parts	Parts No.	Description	Destination
C827			CK73GB1H103K	CHIP C 0.010UF K		L207			L34-4607-15	AIR-CORE COIL	
C848			C92-0904-05	OS-CON 22UF 35WV		L208			L34-4606-15	AIR-CORE COIL	
C850			CK73GB1H103K	CHIP C 0.010UF K		L210			L41-1595-33	SMALL FIXED INDUCTOR (1.5UH)	
C856			CE32AU1E100M	CHIP EL 10UF 25WV		L211			L41-1895-33	SMALL FIXED INDUCTOR (1.8UH)	
C857			CK73GB1H103K	CHIP C 0.010UF K		L212,213			L41-1005-33	SMALL FIXED INDUCTOR (10UH)	
C858,859			CC73GCH1H471J	CHIP C 470PF J		L214,215			L41-4705-33	SMALL FIXED INDUCTOR (47UH)	
C860			CK73GB1H103K	CHIP C 0.010UF K		L216,217			L41-2295-33	SMALL FIXED INDUCTOR (2.2UH)	
C885			CK73GB1H104K	CHIP C 0.10UF K		L218			L41-6885-33	SMALL FIXED INDUCTOR (0.68UH)	
C886			CC73GCH1H270J	CHIP C 27PF J		L219			L41-6895-33	SMALL FIXED INDUCTOR (6.8UH)	
C887			CC73GCH1H100D	CHIP C 10PF D		L301			L41-3985-33	SMALL FIXED INDUCTOR (0.39UH)	
C888			CC73GCH1H270J	CHIP C 27PF J		L302			L41-1005-33	SMALL FIXED INDUCTOR (10UH)	
C889			CK73GB1H104K	CHIP C 0.10UF K		L303			L41-1095-33	SMALL FIXED INDUCTOR (1.0UH)	
C890			CK73GB1E105K	CHIP C 1.0UF K		L304			L41-1005-33	SMALL FIXED INDUCTOR (10UH)	
C894,895			CK73GB1H103K	CHIP C 0.010UF K		L305			L41-3385-33	SMALL FIXED INDUCTOR (0.33UH)	
C896			CC73GCH1H100D	CHIP C 10PF D		L306			L41-1095-33	SMALL FIXED INDUCTOR (1.0UH)	
C920-925			CK73GB1H104K	CHIP C 0.10UF K		L307,308			L41-3985-33	SMALL FIXED INDUCTOR (0.39UH)	
C926			CK73GB1H102K	CHIP C 1000PF K		L309			L41-1095-33	SMALL FIXED INDUCTOR (1.0UH)	
C928,929			CK73GB1H104K	CHIP C 0.10UF K		L310			L41-3385-33	SMALL FIXED INDUCTOR (0.33UH)	
C930,931			CK73GB1E105K	CHIP C 1.0UF K		L311			L41-3985-33	SMALL FIXED INDUCTOR (0.39UH)	
C932			CC73GCH1H470J	CHIP C 47PF J		L312			L41-3385-33	SMALL FIXED INDUCTOR (0.33UH)	
C933,934			CS77CA1A1R5M	CHIP TNTL 1.5UF 10WV		L313			L41-1095-33	SMALL FIXED INDUCTOR (1.0UH)	
C935,936			CK73GB1H104K	CHIP C 0.10UF K		L314			L41-1005-33	SMALL FIXED INDUCTOR (10UH)	
C937			CK73GB1H103K	CHIP C 0.010UF K		L401-403			L41-1095-33	SMALL FIXED INDUCTOR (1.0UH)	
C938			CK73FBQJ106K	CHIP C 10UF K		L404			L41-1005-33	SMALL FIXED INDUCTOR (10UH)	
C939			CK73GB1H102K	CHIP C 1000PF K		L405			L41-3385-33	SMALL FIXED INDUCTOR (0.33UH)	
C941			CK73GB1H102K	CHIP C 1000PF K		L406			L41-1005-33	SMALL FIXED INDUCTOR (10UH)	
C943			CK73GB1H104K	CHIP C 0.10UF K		L407			L41-3985-33	SMALL FIXED INDUCTOR (0.39UH)	
C960-965			CK73GB1H104K	CHIP C 0.10UF K		L408			L41-1095-33	SMALL FIXED INDUCTOR (1.0UH)	
CN102-121			E23-1280-05	TERMINAL		L409,410			L41-3385-33	SMALL FIXED INDUCTOR (0.33UH)	
CN130			E23-1330-05	TERMINAL		L411			L41-3985-33	SMALL FIXED INDUCTOR (0.39UH)	
CN403			E04-0193-05	PIN SOCKET		L412			L41-1095-33	SMALL FIXED INDUCTOR (1.0UH)	
CN405,406			E04-0193-05	PIN SOCKET		L413			L41-3985-33	SMALL FIXED INDUCTOR (0.39UH)	
CN407			E04-0154-05	PIN SOCKET		L414,415			L41-1095-33	SMALL FIXED INDUCTOR (1.0UH)	
CN408			E04-0193-05	PIN SOCKET		L416,417			L41-1005-33	SMALL FIXED INDUCTOR (10UH)	
CN801			E41-2672-05	PIN ASSY		L418			L41-5685-33	SMALL FIXED INDUCTOR (0.56UH)	
CN802			E04-0193-05	PIN SOCKET		L419,420			L41-6885-33	SMALL FIXED INDUCTOR (0.68UH)	
CN803			E40-6822-05	FLAT CABLE CONNECTOR		L421			L41-5685-33	SMALL FIXED INDUCTOR (0.56UH)	
CN804-806			E40-6656-05	PIN ASSY		L422			L39-1517-05	TOROIDAL COIL	
CN807			E41-2671-05	PIN ASSY		L423			L41-3305-33	SMALL FIXED INDUCTOR (33UH)	
CN920			E41-1493-05	PIN ASSY		L424			L39-1517-05	TOROIDAL COIL	
CN921			E40-6656-05	PIN ASSY		L425			L41-3305-33	SMALL FIXED INDUCTOR (33UH)	
CN923			E41-1493-05	PIN ASSY		L426,427			L39-1517-05	TOROIDAL COIL	
CN960			E41-1493-05	PIN ASSY		L430			L41-5685-33	SMALL FIXED INDUCTOR (0.56UH)	
E100			F10-3081-04	SHIELDING CASE		L431			L41-6885-33	SMALL FIXED INDUCTOR (0.68UH)	
CF201			L72-1029-05	CERAMIC FILTER (4.5MHZ)		L433,434			L41-3985-33	SMALL FIXED INDUCTOR (0.39UH)	
CF601			L72-1019-05	CERAMIC FILTER (6MHZ)		L435			L41-2205-33	SMALL FIXED INDUCTOR (22UH)	
L105,106			L41-1095-33	SMALL FIXED INDUCTOR (1.0UH)		L601,602			L41-3305-33	SMALL FIXED INDUCTOR (33UH)	
L108			L34-4545-05	AIR-CORE COIL		L603,604			L41-4705-33	SMALL FIXED INDUCTOR (47UH)	
L109-111			L41-1095-33	SMALL FIXED INDUCTOR (1.0UH)		L605			L41-2205-33	SMALL FIXED INDUCTOR (22UH)	
L112,113			L41-1875-33	SMALL FIXED INDUCTOR (0.018UH)		L606,607			L41-1205-33	SMALL FIXED INDUCTOR (12UH)	
L116-119			L41-1575-33	SMALL FIXED INDUCTOR (0.015UH)		L608			L41-1005-33	SMALL FIXED INDUCTOR (10UH)	
L120			L41-2275-33	SMALL FIXED INDUCTOR (0.022UH)		L609			L92-0140-05	CHIP FERRITE	
L121-124			L41-1005-33	SMALL FIXED INDUCTOR (10UH)		L610			L41-1005-33	SMALL FIXED INDUCTOR (10UH)	
L125,126			L41-1095-33	SMALL FIXED INDUCTOR (1.0UH)		L611			L92-0140-05	CHIP FERRITE	
L128			L34-4545-05	AIR-CORE COIL		L612			L41-3385-33	SMALL FIXED INDUCTOR (0.33UH)	
L129-131			L41-1095-33	SMALL FIXED INDUCTOR (1.0UH)		L613			L41-3985-33	SMALL FIXED INDUCTOR (0.39UH)	
L201,202			L41-1575-33	SMALL FIXED INDUCTOR (0.015UH)		L614			L41-1005-33	SMALL FIXED INDUCTOR (10UH)	
L203,204			L41-1275-33	SMALL FIXED INDUCTOR (0.012UH)		L801			L41-1095-33	SMALL FIXED INDUCTOR (1.0UH)	
L205			L34-4604-15	AIR-CORE COIL		L812			L41-1005-33	SMALL FIXED INDUCTOR (10UH)	
						X301			L77-1981-05	VCXO (19.2MHZ)	

## PARTS LIST

TX UNIT (X56-3120-12)

Ref. No.	Address	New parts	Parts No.	Description	Desti-nation	Ref. No.	Address	New parts	Parts No.	Description	Desti-nation
X401			L77-1981-05	VCXO (19.2MHZ)		R201			RK73GB2A121J	CHIP R 120 J 1/10W	
X601			L77-3034-05	TCXO (19.2MHZ)		R202			RK73GB2A470J	CHIP R 47 J 1/10W	
CP920			RK74GB1J102J	CHIP-COM 1.0K J 1/16W		R203			RK73GB2A121J	CHIP R 120 J 1/10W	
CP923			RK74GB1J102J	CHIP-COM 1.0K J 1/16W		R204			RK73GB2A103J	CHIP R 10K J 1/10W	
CP924			RK75GB1JR00	CHIP-COM 0.00 1/16W		R205			RK73GB2A272J	CHIP R 2.7K J 1/10W	
CP926			RK74GB1J681J	CHIP-COM 680 J 1/16W		R206			RK73GB2A181J	CHIP R 180 J 1/10W	
CP928			RK74GB1J681J	CHIP-COM 680 J 1/16W		R207			RK73GB2A121J	CHIP R 120 J 1/10W	
CP961,962			RK74GB1J102J	CHIP-COM 1.0K J 1/16W		R208			RK73GB2A101J	CHIP R 100 J 1/10W	
CP965,966			RK74GB1J102J	CHIP-COM 1.0K J 1/16W		R210			RK73GB2A000J	CHIP R 0.0 J 1/10W	
CP970,971			RK74GB1J102J	CHIP-COM 1.0K J 1/16W		R212			RK73GB2A562J	CHIP R 5.6K J 1/10W	
CP973,974			RK74GB1J102J	CHIP-COM 1.0K J 1/16W		R213			RK73GB2A152J	CHIP R 1.5K J 1/10W	
R101			RK73GB2A000J	CHIP R 0.0 J 1/10W		R215			RK73GB2A000J	CHIP R 0.0 J 1/10W	
R118			RK73GB2A000J	CHIP R 0.0 J 1/10W		R216			RK73GB2A470J	CHIP R 47 J 1/10W	
R119			RK73GB2A820J	CHIP R 82 J 1/10W		R218			RK73GB2A000J	CHIP R 0.0 J 1/10W	
R120			RK73GB2A151J	CHIP R 150 J 1/10W		R220			RK73GB2A392J	CHIP R 3.9K J 1/10W	
R123			RK73GB2A000J	CHIP R 0.0 J 1/10W		R221			RK73GB2A103J	CHIP R 10K J 1/10W	
R124,125			RK73GB2A105J	CHIP R 1.0M J 1/10W		R222			RK73GB2A000J	CHIP R 0.0 J 1/10W	
R129			RK73GB2A101J	CHIP R 100 J 1/10W		R223			RK73GB2A123J	CHIP R 12K J 1/10W	
R131			RN73GE1J101D	CHIP R 100 D 1/16W		R224			RK73GB2A221J	CHIP R 220 J 1/10W	
R132			RN73GE1J181D	CHIP R 180 D 1/16W		R225			RK73GB2A474J	CHIP R 470K J 1/10W	
R133			RK73GB2A470J	CHIP R 47 J 1/10W		R226			RK73GB2A220J	CHIP R 22 J 1/10W	
R134			RK73GB2A220J	CHIP R 22 J 1/10W		R227			RK73GB2A000J	CHIP R 0.0 J 1/10W	
R135			RK73GB2A272J	CHIP R 2.7K J 1/10W		R229			RK73GB2A563J	CHIP R 56K J 1/10W	
R137			RK73GB2A102J	CHIP R 1.0K J 1/10W		R230			RK73FB2B4R7J	CHIP R 4.7 J 1/8W	
R138			RK73GB2A103J	CHIP R 10K J 1/10W		R231,232			RK73GB2A000J	CHIP R 0.0 J 1/10W	
R139			RK73GB2A102J	CHIP R 1.0K J 1/10W		R233			RK73GB2A104J	CHIP R 100K J 1/10W	
R141			RK73GB2A820J	CHIP R 82 J 1/10W		R234,235			RK73GB2A474J	CHIP R 470K J 1/10W	
R142			RK73GB2A331J	CHIP R 330 J 1/10W		R236			RK73GB2A821J	CHIP R 820 J 1/10W	
R144,145			RK73GB2A000J	CHIP R 0.0 J 1/10W		R241			RK73GB2A000J	CHIP R 0.0 J 1/10W	
R146			RK73GB2A271J	CHIP R 270 J 1/10W		R242			RK73GB2A474J	CHIP R 470K J 1/10W	
R147			RK73GB2A180J	CHIP R 18 J 1/10W		R243			RK73GB2A392J	CHIP R 3.9K J 1/10W	
R148			RK73GB2A271J	CHIP R 270 J 1/10W		R244-246			RK73GB2A102J	CHIP R 1.0K J 1/10W	
R149			RK73GB2A221J	CHIP R 220 J 1/10W		R247-249			RK73GB2A104J	CHIP R 100K J 1/10W	
R150			RK73GB2A820J	CHIP R 82 J 1/10W		R250			RK73GB2A474J	CHIP R 470K J 1/10W	
R151			RK73GB2A101J	CHIP R 100 J 1/10W		R251			RK73GB2A100J	CHIP R 10 J 1/10W	
R152			RK73GB2A000J	CHIP R 0.0 J 1/10W		R252			RK73GB2A104J	CHIP R 100K J 1/10W	
R153			RK73GB2A271J	CHIP R 270 J 1/10W		R253			RK73GB2A331J	CHIP R 330 J 1/10W	
R154			RK73GB2A180J	CHIP R 18 J 1/10W		R254			RK73GB2A100J	CHIP R 10 J 1/10W	
R155			RK73GB2A682J	CHIP R 6.8K J 1/10W		R255			RK73GB2A274J	CHIP R 270K J 1/10W	
R156			RK73GB2A182J	CHIP R 1.8K J 1/10W		R256			RK73GB2A102J	CHIP R 1.0K J 1/10W	
R157			RK73GB2A271J	CHIP R 270 J 1/10W		R257,258			RK73GB2A000J	CHIP R 0.0 J 1/10W	
R158			RK73GB2A103J	CHIP R 10K J 1/10W		R259			RK73GB2A562J	CHIP R 5.6K J 1/10W	
R159-161			RK73GB2A104J	CHIP R 100K J 1/10W		R260			RK73GB2A331J	CHIP R 330 J 1/10W	
R164			RK73GB2A104J	CHIP R 100K J 1/10W		R261			RK73GB2A562J	CHIP R 5.6K J 1/10W	
R165-168			RK73GB2A102J	CHIP R 1.0K J 1/10W		R262			RK73GB2A102J	CHIP R 1.0K J 1/10W	
R170			RK73GB2A000J	CHIP R 0.0 J 1/10W		R263			RK73GB2A563J	CHIP R 56K J 1/10W	
R171,172			RK73GB2A470J	CHIP R 47 J 1/10W		R264			RK73GB2A100J	CHIP R 10 J 1/10W	
R173,174			RK73GB2A102J	CHIP R 1.0K J 1/10W		R265			RK73GB2A471J	CHIP R 470 J 1/10W	
R176			RK73GB2A000J	CHIP R 0.0 J 1/10W		R266			RK73GB2A000J	CHIP R 0.0 J 1/10W	
R178			RK73GB2A000J	CHIP R 0.0 J 1/10W		R267			RK73GB2A271J	CHIP R 270 J 1/10W	
R179			RK73GB2A224J	CHIP R 220K J 1/10W		R268			RK73GB2A180J	CHIP R 18 J 1/10W	
R180			RK73GB2A101J	CHIP R 100 J 1/10W		R269			RK73GB2A271J	CHIP R 270 J 1/10W	
R181			RK73GB2A184J	CHIP R 180K D 1/10W		R270,271			RK73GB2A472J	CHIP R 4.7K J 1/10W	
R182			RN73GE1J151D	CHIP R 150 D 1/16W		R272			RK73GB2A100J	CHIP R 10 J 1/10W	
R183			RN73GE1J181D	CHIP R 180 J 1/16W		R274			RK73GB2A221J	CHIP R 220 J 1/10W	
R184			RK73GB2A470J	CHIP R 47 J 1/10W		R276			RK73GB2A000J	CHIP R 0.0 J 1/10W	
R185,186			RK73GB2A103J	CHIP R 10K J 1/10W		R301,302			RK73GB2A473J	CHIP R 47K J 1/10W	
R187,188			RK73GB2A000J	CHIP R 0.0 J 1/10W		R303			RK73GB2A000J	CHIP R 0.0 J 1/10W	
R189-191			RK73GB2A103J	CHIP R 10K J 1/10W		R304			RK73GB2A471J	CHIP R 470 J 1/10W	
						R305			RK73GB2A104J	CHIP R 100K J 1/10W	

## PARTS LIST

### TX UNIT (X56-3120-12)

Ref. No.	Address	New parts	Parts No.	Description	Destination	Ref. No.	Address	New parts	Parts No.	Description	Destination
R306-309			RK73GB2A102J	CHIP R 1.0K J 1/10W		R415			RK73GB2A123J	CHIP R 12K J 1/10W	
R310,311			RK73GB2A104J	CHIP R 100K J 1/10W		R416			RK73GB2A562J	CHIP R 5.6K J 1/10W	
R312			RK73GB2A154J	CHIP R 150K J 1/10W		R417,418			RK73GB2A000J	CHIP R 0.0 J 1/10W	
R313			RK73GB2A2R2J	CHIP R 2.2 J 1/10W		R422-424			RK73GB2A474J	CHIP R 470K J 1/10W	
R314			RK73GB2A000J	CHIP R 0.0 J 1/10W		R425			RK73GB2A104J	CHIP R 100K J 1/10W	
R316			RK73GB2A223J	CHIP R 22K J 1/10W		R427			RK73GB2A100J	CHIP R 10 J 1/10W	
R317			RK73GB2A104J	CHIP R 100K J 1/10W		R430,431			RK73GB2A100J	CHIP R 10 J 1/10W	
R318			RK73GB2A472J	CHIP R 4.7K J 1/10W		R433			RK73GB2A102J	CHIP R 1.0K J 1/10W	
R319			RK73GB2A104J	CHIP R 100K J 1/10W		R434			RK73GB2A000J	CHIP R 0.0 J 1/10W	
R320			RK73GB2A470J	CHIP R 47 J 1/10W		R435			RK73GB2A104J	CHIP R 100K J 1/10W	
R321-323			RK73GB2A100J	CHIP R 10 J 1/10W		R436,437			RK73GB2A102J	CHIP R 1.0K J 1/10W	
R324			RK73GB2A682J	CHIP R 6.8K J 1/10W		R438			RK73GB2A104J	CHIP R 100K J 1/10W	
R325			RK73GB2A332J	CHIP R 3.3K J 1/10W		R439			RK73GB2A2R2J	CHIP R 2.2 J 1/10W	
R326			RK73GB2A100J	CHIP R 10 J 1/10W		R440			RK73GB2A103J	CHIP R 10K J 1/10W	
R327,328			RK73GB2A000J	CHIP R 0.0 J 1/10W		R442			RK73GB2A470J	CHIP R 47 J 1/10W	
R329,330			RK73GB2A104J	CHIP R 100K J 1/10W		R447			RK73GB2A000J	CHIP R 0.0 J 1/10W	
R331,332			RK73GB2A471J	CHIP R 470 J 1/10W		R452,453			RK73GB2A000J	CHIP R 0.0 J 1/10W	
R333			RK73GB2A000J	CHIP R 0.0 J 1/10W		R454,455			RK73GB2A105J	CHIP R 1.0M J 1/10W	
R334			RK73GB2A823J	CHIP R 82K J 1/10W		R457			RK73GB2A333J	CHIP R 33K J 1/10W	
R335			RK73GB2A223J	CHIP R 22K J 1/10W		R458			RK73GB2A104J	CHIP R 100K J 1/10W	
R336			RK73GB2A334J	CHIP R 330K J 1/10W		R459			RK73GB2A472J	CHIP R 4.7K J 1/10W	
R337			RK73GB2A273J	CHIP R 27K J 1/10W		R460			RK73GB2A183J	CHIP R 18K J 1/10W	
R338			RK73GB2A105J	CHIP R 1.0M J 1/10W		R461			RK73GB2A000J	CHIP R 0.0 J 1/10W	
R339			RK73GB2A104J	CHIP R 100K J 1/10W		R463			RK73GB2A000J	CHIP R 0.0 J 1/10W	
R340			RK73GB2A101J	CHIP R 100 J 1/10W		R464			RK73GB2A221J	CHIP R 220 J 1/10W	
R341			RK73GB2A221J	CHIP R 220 J 1/10W		R465			RK73GB2A000J	CHIP R 0.0 J 1/10W	
R342			RK73GB2A470J	CHIP R 47 J 1/10W		R466			RK73GB2A470J	CHIP R 47 J 1/10W	
R343			RK73GB2A000J	CHIP R 0.0 J 1/10W		R469,470			RK73GB2A000J	CHIP R 0.0 J 1/10W	
R344-351			RK73GB2A104J	CHIP R 100K J 1/10W		R471			RK73GB2A102J	CHIP R 1.0K J 1/10W	
R352			RK73GB2A123J	CHIP R 12K J 1/10W		R474			RK73GB2A682J	CHIP R 6.8K J 1/10W	
R353			RK73GB2A332J	CHIP R 3.3K J 1/10W		R475			RK73GB2A332J	CHIP R 3.3K J 1/10W	
R355			RK73GB2A221J	CHIP R 220 J 1/10W		R476,477			RK73GB2A000J	CHIP R 0.0 J 1/10W	
R356			RK73GB2A100J	CHIP R 10 J 1/10W		R478			RK73GB2A153J	CHIP R 15K J 1/10W	
R357			RK73GB2A101J	CHIP R 100 J 1/10W		R479			RK73GB2A2R2J	CHIP R 2.2 J 1/10W	
R358			RK73GB2A105J	CHIP R 1.0M J 1/10W		R480			RK73GB2A682J	CHIP R 6.8K J 1/10W	
R360			RK73GB2A104J	CHIP R 100K J 1/10W		R481			RK73GB2A182J	CHIP R 1.8K J 1/10W	
R362			RK73GB2A100J	CHIP R 10 J 1/10W		R482			RK73GB2A103J	CHIP R 10K J 1/10W	
R363			RK73GB2A471J	CHIP R 470 J 1/10W		R483			RK73GB2A562J	CHIP R 5.6K J 1/10W	
R364			RK73GB2A104J	CHIP R 100K J 1/10W		R484			RK73GB2A101J	CHIP R 100 J 1/10W	
R367			RK73GB2A104J	CHIP R 100K J 1/10W		R485			RK73GB2A392J	CHIP R 3.9K J 1/10W	
R368			RK73GB2A822J	CHIP R 8.2K J 1/10W		R486			RK73GB2A221J	CHIP R 220 J 1/10W	
R369			RK73GB2A000J	CHIP R 0.0 J 1/10W		R487			RK73GB2A102J	CHIP R 1.0K J 1/10W	
R370			RK73GB2A182J	CHIP R 1.8K J 1/10W		R488			RK73GB2A822J	CHIP R 8.2K J 1/10W	
R371			RK73GB2A2R2J	CHIP R 2.2 J 1/10W		R489			RK73GB2A272J	CHIP R 2.7K J 1/10W	
R374			RK73GB2A000J	CHIP R 0.0 J 1/10W		R490			RK73GB2A470J	CHIP R 47 J 1/10W	
R375,376			RK73GB2A563J	CHIP R 56K J 1/10W		R492			RK73GB2A471J	CHIP R 470 J 1/10W	
R377,378			RK73GB2A104J	CHIP R 100K J 1/10W		R493			RK73GB2A104J	CHIP R 100K J 1/10W	
R379			RK73GB2A000J	CHIP R 0.0 J 1/10W		R494			RK73GB2A123J	CHIP R 12K J 1/10W	
R380			RK73GB2A470J	CHIP R 47 J 1/10W		R495			RK73GB2A332J	CHIP R 3.3K J 1/10W	
R381			RK73GB2A104J	CHIP R 100K J 1/10W		R496,497			RK73GB2A100J	CHIP R 10 J 1/10W	
R401			RK73GB2A000J	CHIP R 0.0 J 1/10W		R498			RK73GB2A471J	CHIP R 470 J 1/10W	
R402			RK73GB2A474J	CHIP R 470K J 1/10W		R499			RK73GB2A682J	CHIP R 6.8K J 1/10W	
R403,404			RK73GB2A102J	CHIP R 1.0K J 1/10W		R500			RK73GB2A332J	CHIP R 3.3K J 1/10W	
R406-408			RK73GB2A100J	CHIP R 10 J 1/10W		R501			RK73GB2A221J	CHIP R 220 J 1/10W	
R409			RK73GB2A000J	CHIP R 0.0 J 1/10W		R502			RK73GB2A000J	CHIP R 0.0 J 1/10W	
R410			RK73GB2A331J	CHIP R 330 J 1/10W		R503			RK73GB2A100J	CHIP R 10 J 1/10W	
R411			RK73GB2A000J	CHIP R 0.0 J 1/10W		R504			RK73GB2A104J	CHIP R 100K J 1/10W	
R412			RK73GB2A331J	CHIP R 330 J 1/10W		R505			RK73GB2A000J	CHIP R 0.0 J 1/10W	
R413			RK73GB2A123J	CHIP R 12K J 1/10W		R506			RK73GB2A101J	CHIP R 100 J 1/10W	
R414			RK73GB2A562J	CHIP R 5.6K J 1/10W		R507			RK73GB2A100J	CHIP R 10 J 1/10W	



## PARTS LIST

TX UNIT (X56-3120-12)

Ref. No.	Address	New parts	Parts No.	Description	Destination	Ref. No.	Address	New parts	Parts No.	Description	Destination
R508-510			RK73GB2A000J	CHIP R 0.0 J 1/10W		R581			RK73GB2A104J	CHIP R 100K J 1/10W	
R511			RK73GB2A102J	CHIP R 1.0K J 1/10W		R582			RK73GB2A474J	CHIP R 470K J 1/10W	
R512			RK73GB2A181J	CHIP R 180 J 1/10W		R583			RK73GB2A221J	CHIP R 220 J 1/10W	
R513			RK73GB2A471J	CHIP R 470 J 1/10W		R586			RK73GB2A104J	CHIP R 100K J 1/10W	
R514			RK73GB2A100J	CHIP R 10 J 1/10W		R588			RK73GB2A103J	CHIP R 10K J 1/10W	
R515			RK73GB2A470J	CHIP R 47 J 1/10W		R591			RK73FB2B271J	CHIP R 270 J 1/8W	
R518			RK73GB2A104J	CHIP R 100K J 1/10W		R592			RK73GB2A273J	CHIP R 27K J 1/10W	
R519			RK73GB2A124J	CHIP R 120K J 1/10W		R593			RK73FB2B120J	CHIP R 12 J 1/8W	
R521			RK73GB2A223J	CHIP R 22K J 1/10W		R594			RK73FB2B271J	CHIP R 270 J 1/8W	
R522			RK73GB2A822J	CHIP R 8.2K J 1/10W		R595			RK73GB2A102J	CHIP R 1.0K J 1/10W	
R523,524			RK73GB2A221J	CHIP R 220 J 1/10W		R601			RK73GB2A103J	CHIP R 10K J 1/10W	
R525			RK73GB2A471J	CHIP R 470 J 1/10W		R602			RK73GB2A104J	CHIP R 100K J 1/10W	
R526			RK73GB2A473J	CHIP R 47K J 1/10W		R603			RK73GB2A222J	CHIP R 2.2K J 1/10W	
R527			RK73GB2A271J	CHIP R 270 J 1/10W		R604			RK73GB2A473J	CHIP R 47K J 1/10W	
R528			RK73GB2A152J	CHIP R 1.5K J 1/10W		R605			RK73GB2A153J	CHIP R 15K J 1/10W	
R529			RK73GB2A153J	CHIP R 15K J 1/10W		R606			RK73GB2A181J	CHIP R 180 J 1/10W	
R530			RK73GB2A120J	CHIP R 12 J 1/10W		R607			RK73GB2A470J	CHIP R 47 J 1/10W	
R531			RK73GB2A474J	CHIP R 470K J 1/10W		R608			RK73GB2A222J	CHIP R 2.2K J 1/10W	
R532			RK73GB2A271J	CHIP R 270 J 1/10W		R610			RK73GB2A104J	CHIP R 100K J 1/10W	
R533			RK73GB2A104J	CHIP R 100K J 1/10W		R611			RK73GB2A100J	CHIP R 10 J 1/10W	
R534			RK73GB2A221J	CHIP R 220 J 1/10W		R612			RK73GB2A471J	CHIP R 470 J 1/10W	
R535			RK73GB2A104J	CHIP R 100K J 1/10W		R613			RK73GB2A682J	CHIP R 6.8K J 1/10W	
R536			RK73GB2A102J	CHIP R 1.0K J 1/10W		R614			RK73GB2A332J	CHIP R 3.3K J 1/10W	
R538			RK73GB2A102J	CHIP R 1.0K J 1/10W		R615			RK73GB2A471J	CHIP R 470 J 1/10W	
R539			RK73GB2A100J	CHIP R 10 J 1/10W		R616			RK73GB2A000J	CHIP R 0.0 J 1/10W	
R540			RK73GB2A474J	CHIP R 470K J 1/10W		R617			RK73GB2A471J	CHIP R 470 J 1/10W	
R541			RK73FB2B1R0J	CHIP R 1.0 J 1/8W		R618			RK73GB2A104J	CHIP R 100K J 1/10W	
R542			RK73GB2A102J	CHIP R 1.0K J 1/10W		R619			RK73GB2A100J	CHIP R 10 J 1/10W	
R543			RK73GB2A220J	CHIP R 22 J 1/10W		R620			RK73GB2A104J	CHIP R 100K J 1/10W	
R544			RK73GB2A104J	CHIP R 100K J 1/10W		R621			RK73GB2A471J	CHIP R 470 J 1/10W	
R545			RK73GB2A470J	CHIP R 47 J 1/10W		R622			RK73GB2A331J	CHIP R 330 J 1/10W	
R547			RK73GB2A472J	CHIP R 4.7K J 1/10W		R623			RK73GB2A392J	CHIP R 3.9K J 1/10W	
R548			RK73GB2A473J	CHIP R 47K J 1/10W		R624			RK73GB2A474J	CHIP R 470K J 1/10W	
R549			RK73GB2A331J	CHIP R 330 J 1/10W		R625			RK73GB2A000J	CHIP R 0.0 J 1/10W	
R550			RK73GB2A104J	CHIP R 100K J 1/10W		R626-628			RK73GB2A102J	CHIP R 1.0K J 1/10W	
R551			RK73GB2A473J	CHIP R 47K J 1/10W		R629			RK73GB2A101J	CHIP R 100 J 1/10W	
R552			RK73GB2A104J	CHIP R 100K J 1/10W		R630			RK73GB2A102J	CHIP R 1.0K J 1/10W	
R553			RK73GB2A223J	CHIP R 22K J 1/10W		R631			RK73GB2A561J	CHIP R 560 J 1/10W	
R554			RK73GB2A180J	CHIP R 18 J 1/10W		R637,638			RK73GB2A472J	CHIP R 4.7K J 1/10W	
R555			RK73GB2A102J	CHIP R 1.0K J 1/10W		R639,640			RK73GH2A104D	CHIP R 100K D 1/10W	
R556			RK73GB2A122J	CHIP R 1.2K J 1/10W		R705			RK73GB2A2R2J	CHIP R 2.2 J 1/10W	
R557			RK73GB2A473J	CHIP R 47K J 1/10W		R706-708			RK73GB2A100J	CHIP R 10 J 1/10W	
R558			RK73GB2A331J	CHIP R 330 J 1/10W		R709			RK73GB2A474J	CHIP R 470K J 1/10W	
R560			RK73GB2A000J	CHIP R 0.0 J 1/10W		R711			RK73GB2A104J	CHIP R 100K J 1/10W	
R561			RK73GB2A102J	CHIP R 1.0K J 1/10W		R712,713			RK73GB2A472J	CHIP R 4.7K J 1/10W	
R562			RK73GB2A104J	CHIP R 100K J 1/10W		R714			RK73GB2A104J	CHIP R 100K J 1/10W	
R563			RK73GB2A473J	CHIP R 47K J 1/10W		R715			RK73GB2A474J	CHIP R 470K J 1/10W	
R564			RK73GB2A223J	CHIP R 22K J 1/10W		R716-718			RK73GB2A100J	CHIP R 10 J 1/10W	
R566			RK73GB2A473J	CHIP R 47K J 1/10W		R719,720			RK73GB2A104J	CHIP R 100K J 1/10W	
R567			RK73GB2A472J	CHIP R 4.7K J 1/10W		R721			RK73GB2A100J	CHIP R 10 J 1/10W	
R568			RK73GB2A224J	CHIP R 220K J 1/10W		R722			RK73GB2A474J	CHIP R 470K J 1/10W	
R569			RK73GB2A561J	CHIP R 560 J 1/10W		R801			RK73GB2A102J	CHIP R 1.0K J 1/10W	
R570			RK73GB2A473J	CHIP R 47K J 1/10W		R802,803			RK73GB2A104J	CHIP R 100K J 1/10W	
R571			RK73GB2A100J	CHIP R 10 J 1/10W		R804-807			RK73GB2A100J	CHIP R 10 J 1/10W	
R573			RK73GB2A104J	CHIP R 100K J 1/10W		R812-824			RK73GB2A000J	CHIP R 0.0 J 1/10W	
R575			RK73GB2A472J	CHIP R 4.7K J 1/10W		R830-837			RK73GB2A000J	CHIP R 0.0 J 1/10W	
R576			RK73FB2B1R0J	CHIP R 1.0 J 1/8W		R840			RK73GB2A000J	CHIP R 0.0 J 1/10W	
R577			RK73GB2A104J	CHIP R 100K J 1/10W		R845			RK73GB2A000J	CHIP R 0.0 J 1/10W	
R578			RK73GB2A000J	CHIP R 0.0 J 1/10W		R865			RK73GB2A104J	CHIP R 100K J 1/10W	
R580			RK73GB2A220J	CHIP R 22 J 1/10W		R866,867			RK73GB2A000J	CHIP R 0.0 J 1/10W	

## PARTS LIST

### TX UNIT (X56-3120-12)

Ref. No.	Address	New parts	Parts No.	Description	Destination	Ref. No.	Address	New parts	Parts No.	Description	Destination
R869			RK73GB2A104J	CHIP R 100K J 1/10W		IC405,406		*	TC75S59F-F	MOS-IC	
R870			RK73GB2A101J	CHIP R 100 J 1/10W		IC407			NJU6368PF1	MOS-IC	
R871,872			RK73GB2A104J	CHIP R 100K J 1/10W		IC408,409			TA75S01F-F	MOS-IC	
R873			RK73GB2A103J	CHIP R 10K J 1/10W		IC601			AD9835BRUZ	MOS-IC	
R877			RK73GB2A104J	CHIP R 100K J 1/10W		IC602			NJU6368PF1	MOS-IC	
R878			RK73GB2A000J	CHIP R 0.0 J 1/10W		IC603			XC6204B332M	MOS-IC	
R879			RK73GB2A104J	CHIP R 100K J 1/10W		IC701			BH2220FVM	ANALOGUE IC	
R883			RK73GB2A000J	CHIP R 0.0 J 1/10W		IC702			S24CS02AFJTBG	ROM IC	
R887-889			RK73GB2A102J	CHIP R 1.0K J 1/10W		IC703			BU4094BCFV	MOS-IC	
R891			RK73GB2A102J	CHIP R 1.0K J 1/10W		IC704			NJM78M08DL1AZB	ANALOGUE IC	
R920-932			RK73GB2A000J	CHIP R 0.0 J 1/10W		IC705,706			NJM78M05DL1AZB	ANALOGUE IC	
R933			RK73GB2A821J	CHIP R 820 J 1/10W		IC801			AD1582	ANALOGUE IC	
R934,935			RK73GB2A000J	CHIP R 0.0 J 1/10W		IC802			AD5312BRM	MOS-IC	
R936,937			RK73GB2A122J	CHIP R 1.2K J 1/10W		IC803			AD7908BRU	MOS-IC	
R938,939			RK73GB2A821J	CHIP R 820 J 1/10W		IC804			LM50BIM3/NOPB	MOS-IC	
R940			RK73GB2A122J	CHIP R 1.2K J 1/10W		IC805,806			TC7SET126FU-F	MOS-IC	
R941			RK73GB2A821J	CHIP R 820 J 1/10W		IC807			NJM78M05DL1AZB	ANALOGUE IC	
R942			RK73GB2A000J	CHIP R 0.0 J 1/10W		IC808,809	1B		NJM7808FA-ZB	BI-POLAR IC	
R943			RK73GH2A224D	CHIP R 220K D 1/10W		IC920-922			TC7SET126FU-F	MOS-IC	
R944,945			RK73GB2A102J	CHIP R 1.0K J 1/10W		IC923-925			BU4094BCFV	MOS-IC	
R946			RK73GB2A103J	CHIP R 10K J 1/10W		IC926			NJM2732V	BI-POLAR IC	
R947			RK73GB2A000J	CHIP R 0.0 J 1/10W		IC960-963			BU4094BCFV	MOS-IC	
R948,949			RK73GH2A104D	CHIP R 100K D 1/10W		Q101			SSM3K15TE(F)	FET	
R950			RK73GH2A822D	CHIP R 8.2K D 1/10W		Q102,103			2SK508NV(K52)	FET	
R951			RK73GB2A122J	CHIP R 1.2K J 1/10W		Q104			2SC3356-A(R24)	TRANSISTOR	
R960-965			RK73GB2A000J	CHIP R 0.0 J 1/10W		Q105			2SC4116(BL)F	TRANSISTOR	
R966,967			RK73GB2A102J	CHIP R 1.0K J 1/10W		Q106			2SC3356-A(R24)	TRANSISTOR	
VR401,402			R32-0754-05	SEMI FIXED VARIABLE RESISTOR		Q107,108			2SC4116(BL)F	TRANSISTOR	
S920-925			S70-0502-05	TACT SWITCH		Q109			2SA1832F	TRANSISTOR	
D101,102			1SV283F	VARIABLE CAPACITANCE DIODE		Q110			SSM3K15TE(F)	FET	
D106			1SV278F	VARIABLE CAPACITANCE DIODE		Q201			2SC3356-A(R24)	TRANSISTOR	
D107,108			1SV283F	VARIABLE CAPACITANCE DIODE		Q202			2SC5337	TRANSISTOR	
D112			1SV278F	VARIABLE CAPACITANCE DIODE		Q203			RD01MUS1-T113	FET	
D201			HSM88AS-E	DIODE		Q204			SSM3K15TE(F)	FET	
D401-403			HSM88AS-E	DIODE		Q205			SSM3J01F	FET	
D404,405			JDP4P02U	DIODE		Q206			SSM3K15TE(F)	FET	
D406,407			HSC119	DIODE		Q210			SSM3K15TE(F)	FET	
D408			HSM88AS-E	DIODE		Q211-213			2SC4617(R)	TRANSISTOR	
D409			CSA70-401L	SURGE ABSORBER		Q301,302			SSM3K15TE(F)	FET	
D601,602			JDP4P02U	DIODE		Q303			2SA1832F	TRANSISTOR	
D603-606			UDZ3.0B	ZENER DIODE		Q304,305			2SC4617(R)	TRANSISTOR	
D933,934			HSM88AS-E	DIODE		Q307			2SC4617(R)	TRANSISTOR	
D935,936			1SS355	DIODE		Q401,402			2SC4617(R)	TRANSISTOR	
D960,961			PSA05-11SRWA	LED		Q405			SSM3K15TE(F)	FET	
IC101			LMX2352TMX/NP	ANALOGUE IC		Q407-409			SSM3K15TE(F)	FET	
IC102			LMC7101BIM5	MOS-IC		Q410			2SA1832F	TRANSISTOR	
IC104			NJM2386ADL3-09	ANALOGUE IC		Q412			2SC4617(R)	TRANSISTOR	
IC201			NJM2904E-ZB	ANALOGUE IC		Q413,414			SSM3K15TE(F)	FET	
IC202			AD9835BRUZ	MOS-IC		Q415-419			2SC4617(R)	TRANSISTOR	
IC301			NJM2732V	BI-POLAR IC		Q420			3SK317-E	FET	
IC302			NJU6368PF1	MOS-IC		Q421			SSM6L05FU-F	FET	
IC303			ADF4001BRUZ	MOS-IC		Q422			RD01MUS1-T113	FET	
IC304			M62364FP-F	MOS-IC		Q423			SSM6L05FU-F	FET	
IC305			NJM2732V	BI-POLAR IC		Q424			SSM3K15TE(F)	FET	
IC306			LMC7101BIM5	MOS-IC		Q425			RD01MUS1-T113	FET	
IC307			NJU6368PF1	MOS-IC		Q426			SSM3J01F	FET	
IC308			NJM2732V	BI-POLAR IC		Q428,429			SSM3K15TE(F)	FET	
IC401			LMC7101BIM5	MOS-IC		Q430,431			3SK317-E	FET	
IC404			ADF4001BRUZ	MOS-IC		Q601			SSM3J01F	FET	
						Q602			SSM3K15TE(F)	FET	



## PARTS LIST

TX UNIT (X56-3120-12)

Ref. No.	Address	New parts	Parts No.	Description	Destination	Ref. No.	Address	New parts	Parts No.	Description	Destination
Q603			2SC4617(R)	TRANSISTOR							
Q604			SSM3K15TE(F)	FET							
Q605			SSM3J01F	FET							
Q606			2SC4617(R)	TRANSISTOR							
Q607-609			SSM3K15TE(F)	FET							
Q701,702			SSM3K15TE(F)	FET							
Q920-930			UMG1N	TRANSISTOR							
Q931			2SC4116(Y)F	TRANSISTOR							
Q932			2SA1586(Y)F	TRANSISTOR							
Q960-976			UMG1N	TRANSISTOR							
TH101,102			157-302-65801	THERMISTOR							

# NXR-800

## EXPLODED VIEW

B	:	N09-2292-05
C	M2 x 8	: N30-2008-43
D	M2.6 x 6	: N30-2606-48
E	M3 x 35	: N30-3035-43
F	M3 x 6 (F)	: N32-3006-43
G	M4 x 8 (F)	: N32-4008-43
H	:	N67-3008-48
J	:	N80-2006-43
K	:	N80-2608-43
L	M2.6 x 8 (Br-Tap)	: N87-2608-48

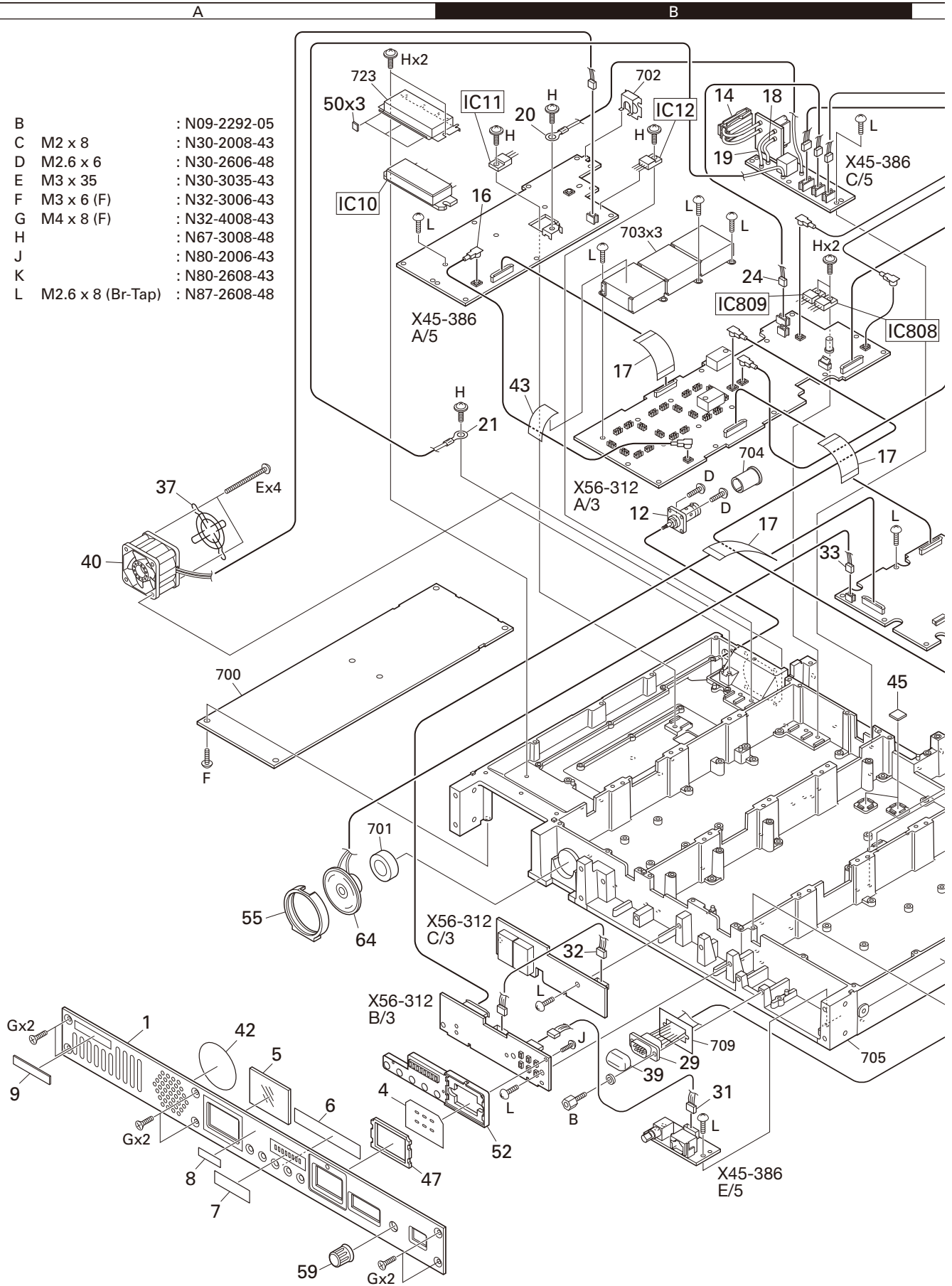

**26** Parts with the exploded numbers larger than 700 are not supplied.  
 If a part reference number is listed in a box on the exploded view of the PCB, that part does not come with the PCB.  
 These parts must be ordered separately.

## EXPLODED VIEW

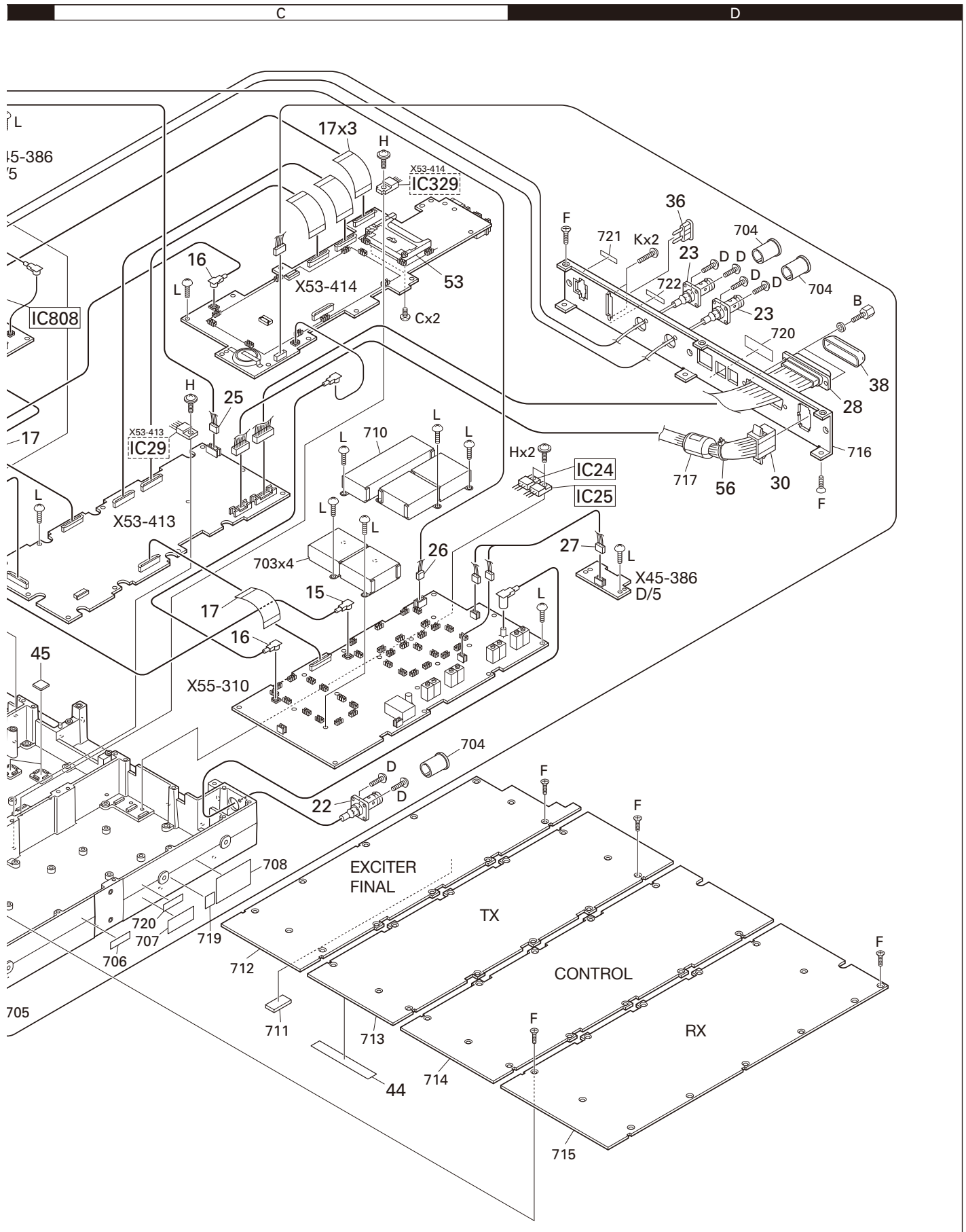

Parts with the exploded numbers larger than 700 are not supplied.

If a part reference number is listed in a box on the exploded view of the PCB, that part does not come with the PCB. These parts must be ordered separately.

## PACKING

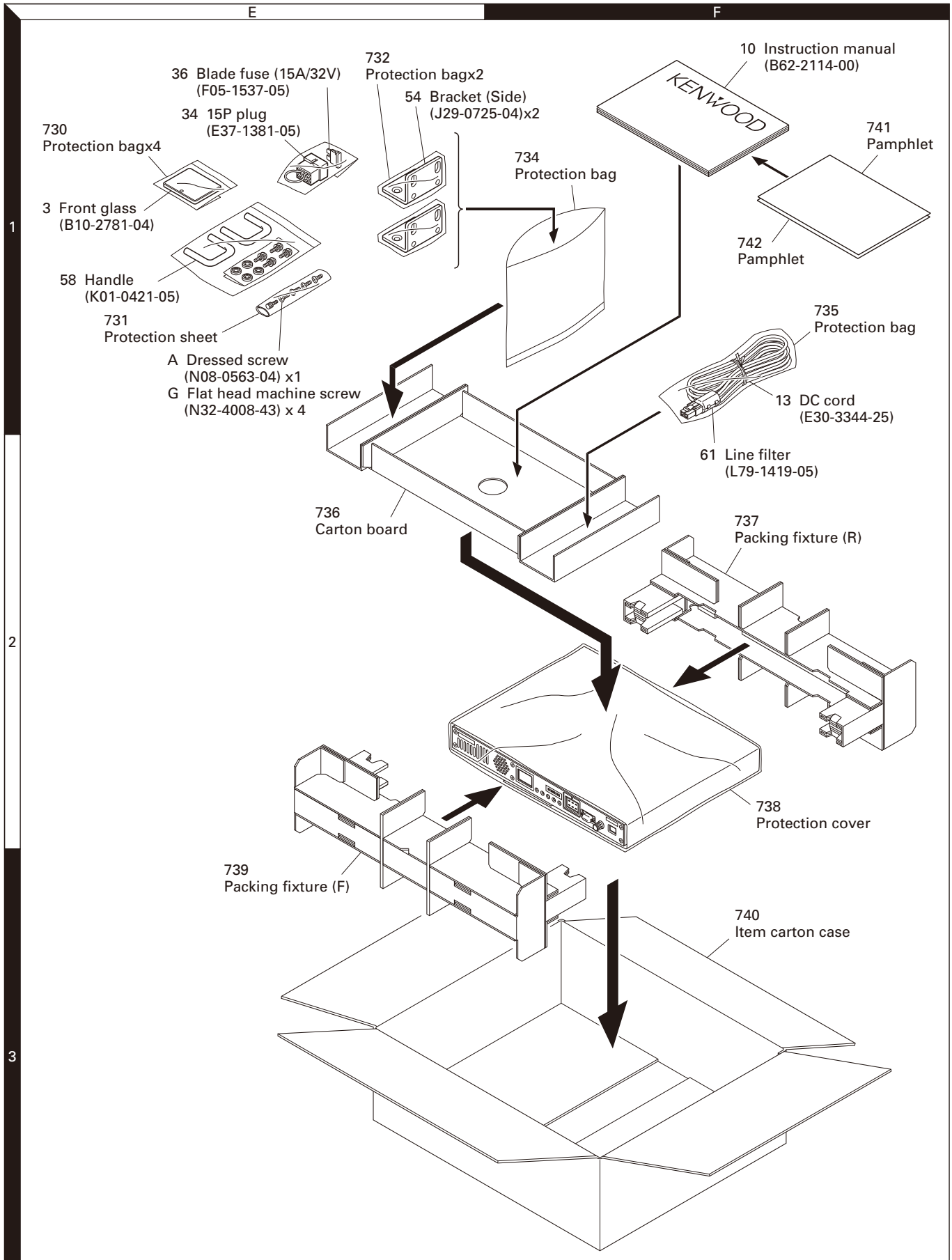

## ADJUSTMENT

### Test Equipment Required for Alignment

Test Equipment	Major Specifications	
1. Standard Signal Generator (SSG)	Frequency Range Modulation Output	400 to 512MHz Frequency modulation and external modulation 0.1 $\mu$ V to greater than 1mV
2. RF Power Meter	Input Impedance Operation Frequency Measurement Capability	50 $\Omega$ 400 to 512MHz or more Vicinity of 100W
3. Deviation Meter	Frequency Range	400 to 512MHz
4. Digital Volt Meter (DVM)	Measuring Range Input Impedance	1V to 20V DC High input impedance for minimum circuit loading
5. Oscilloscope		DC through 30MHz
6. High Sensitivity Frequency Counter	Frequency Range Frequency Stability	10Hz to 600MHz 0.2ppm or less
7. DC Ammeter		15A or more
8. AF Volt Meter (AF V.M)	Frequency Range Voltage Range	50Hz to 10kHz 3mV to 3V
9. Audio Generator (AG)	Frequency Range Output	50Hz to 5kHz 0 to 1V
10. Distortion Meter	Capability Input Level	1% or less at 1kHz 50mV to 10Vrms
11. Voltmeter	Measuring Range Input Impedance	10V to 1.5V DC or less 50k $\Omega$ /V or greater
12. 4 $\Omega$ Dummy Load		Approx. 4 $\Omega$ , 5W
13. Spectrum Analyzer	Frequency Range Input Level Input Sensitivity Resolution Bandwidth Video Bandwidth	40MHz to 520MHz Up to +20dBm -100dBm 100Hz 100Hz
14. Tracking Generator	Frequency Range Output Level	40MHz to 520MHz -30dBm to 0dBm

### MIC connector (Front panel view)

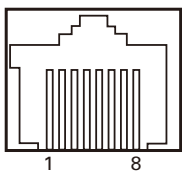

- 1: NC
- 2: SB
- 3: GND
- 4: PTT
- 5: MIG
- 6: MIC
- 7: HOOK
- 8: NC

### Jig for MCF adjustment (W05-1000-00)

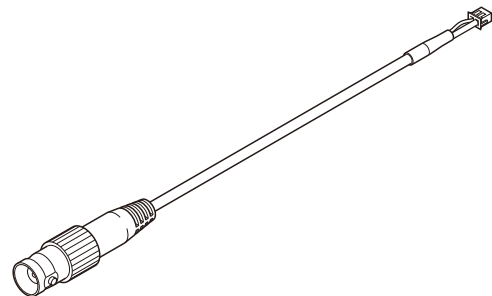

### Test cable for microphone input (E30-3360-18)

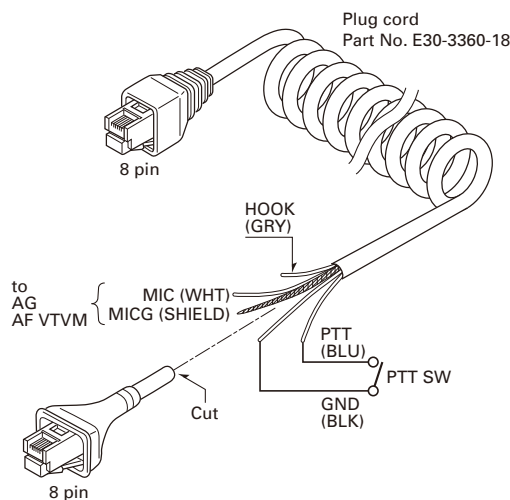

### Jig for Drive AMP adjustment (E30-3228-15 or E37-1304-05)

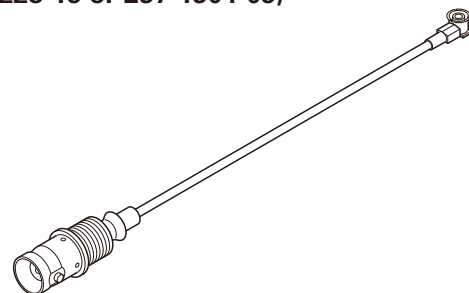

## ADJUSTMENT

Flat cable (36-pin) about 256mm (E37-0979-05)

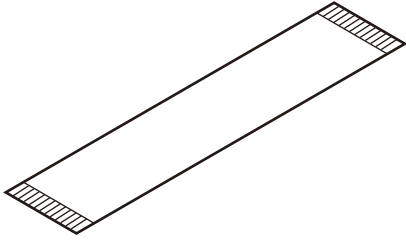

ANT Jig for BPF adjustment (E30-3418-08)

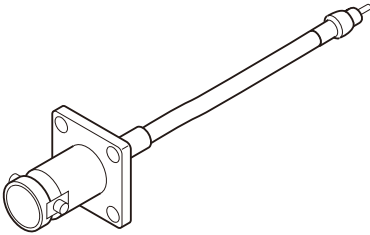

### Test Signaling

#### Analog

No.	Decode tone	Encode tone
1	None	None
2	None	100Hz square wave
3	QT 67.0Hz	QT 67.0Hz
4	QT 151.4Hz	QT 151.4Hz
5	QT 210.7Hz	QT 210.7Hz
6	QT 254.1Hz	1QT 254.1Hz
7	DQT D023N	DQT D023N
8	DQT D754I	DQT D754I
9	None	CWID encode (ID: VVV)
10	None	Single tone
11	DTMF decode (Code: 159D)	DTMF encode (Code: 159D)
12	None	DTMF encode (Code: 9)
13	None	Courtesy tone

#### NXDN

No.	Decode tone	Encode tone
1	RAN1	RAN1
2	RAN1	PN9
3	RAN1	Maximum deviation pattern

- Signaling number 1 is used for link test with voice.
- Signaling number 2 is used for TX modulation signal quality test. i.e, TX adjacent channel power, FSK error, Occupied bandwidth, Emission mask, etc.
- Signaling number 3 is used for TX deviation test. If the modulation mode is very narrow, the modulation frequency is 600Hz. If the modulation mode is narrow, the modulation frequency is 1200Hz.

#### BPF

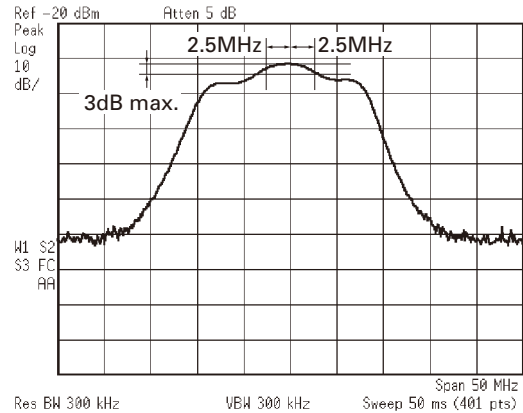

BPF center frequency (Production default): 415MHz  
Pass bandwidth:  $\pm 2.5$ MHz at 3dB

Fig. 1

#### MCF (Wide)

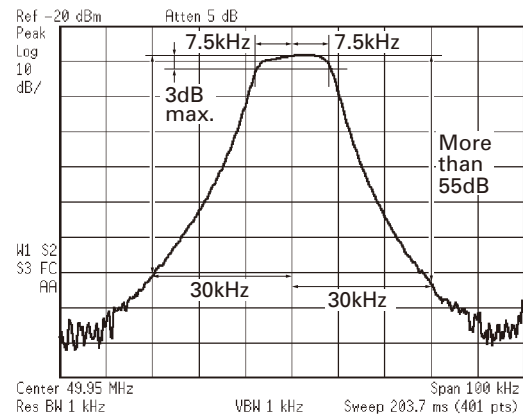

Center frequency: 49.95MHz  
Pass bandwidth:  $\pm 7.5$ MHz at 3dB

Fig. 2

#### MCF (Narrow)

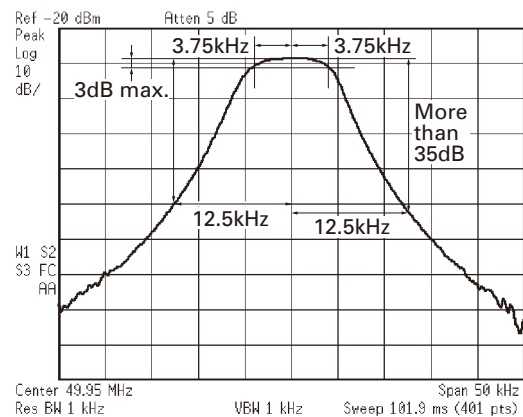

Center frequency: 49.95MHz  
Pass bandwidth:  $\pm 3.75$ MHz at 3dB

Fig. 3

## ADJUSTMENT

### Adjustment Points

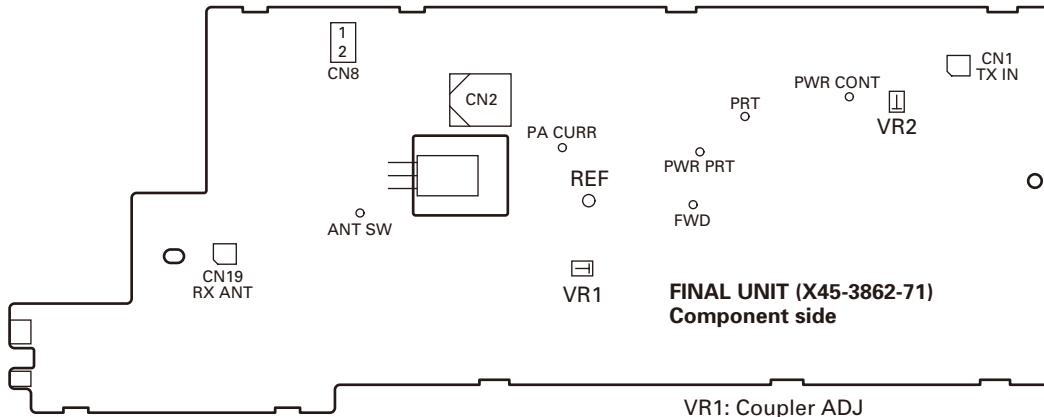

VR1: Coupler ADJ  
VR2: High Transmit Power (Pre ADJ)

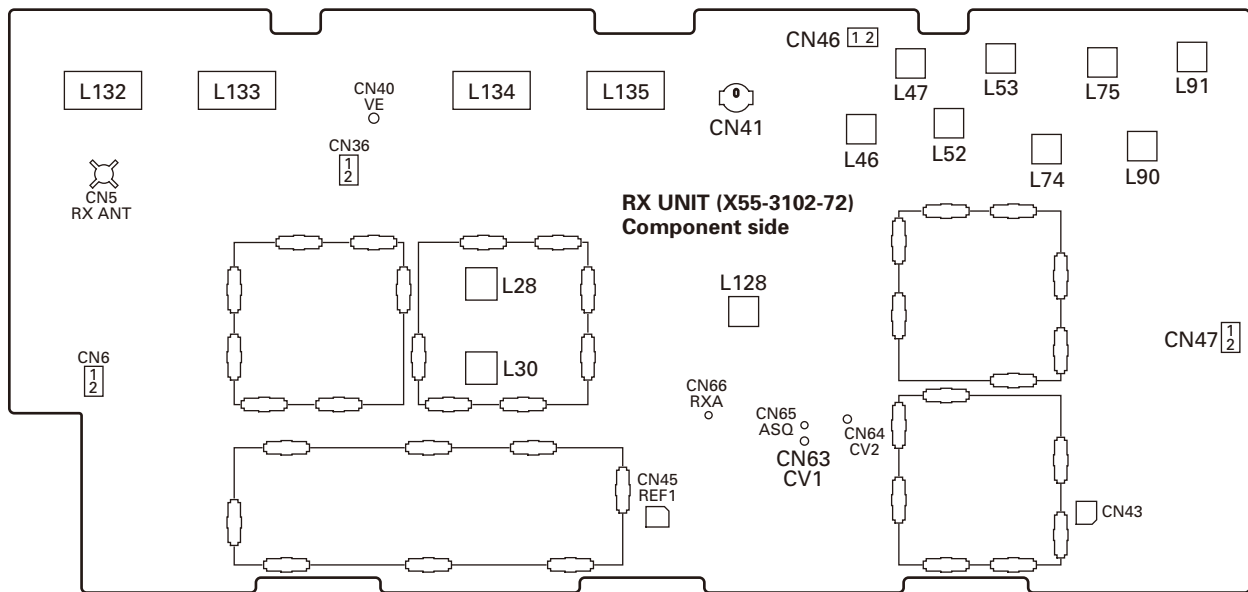

L28,30: Receive VCO Lock Voltage (Adjustment)  
L132~135: BPF

L46,52,74,90: MCF WIDE  
L47,53,75,91: MCF NARROW  
L128: Discriminator

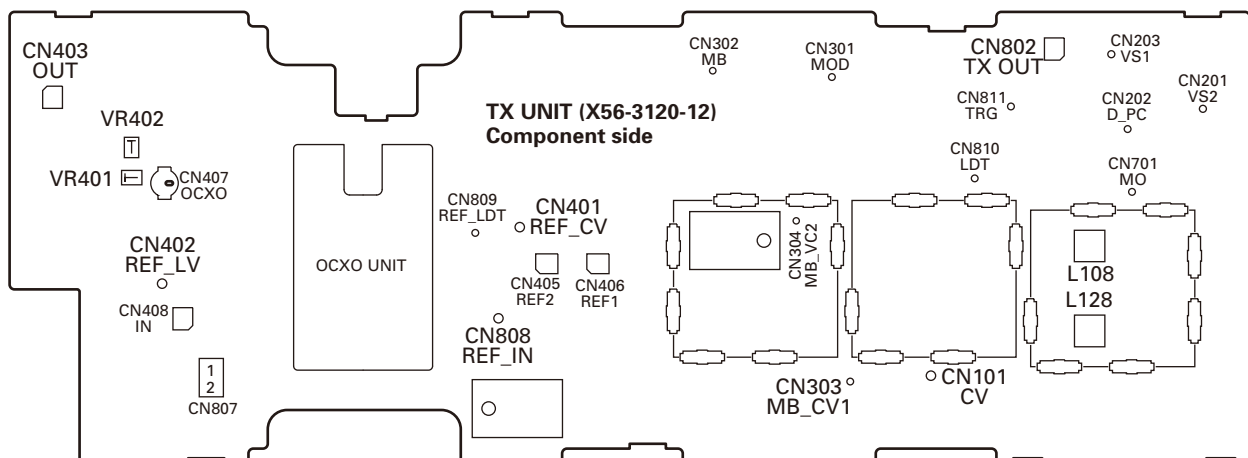

L108,128: Transmit VCO Lock Voltage (Adjustment)  
VR401,402: Reference Signal

## ADJUSTMENT

### Alignment

Item	Condition	Measurement			Adjustment			Specifications / Remarks
		Test-equipment	Unit	Terminal	Unit	Parts	Method	
1. Setting	1) Connect the DC power output to the rear panel DC terminal (13.2V). 2) Connect the front panel COM port (D-sub 9 connector) to the PC serial port with a cross-wired cable. 3) Activate the FPU to go to the test mode.							
2. Temperature Sensor	1) Receive unit (Celsius or Fahrenheit)	Thermometer		Room temperature	RX	PC ADJ	Measuring room temperature, write the value with PC.	
	2) Transmit unit (Celsius or Fahrenheit)				TX			
3. Driver Amplifier Power (Pre ADJ)	1) Low 2) Center 3) High					PC ADJ	Value: 1	Fixed value writing
4. RF Power Down Detection	1) High 2) Low					PC ADJ	Value: 1	Fixed value writing
5. VCTCXO Lock Voltage	1) REF Low SSG frequency: 10MHz -10ppm (9.99999MHz) SSG output: 0dBm	SSG DVM	TX	REF IN REF CV (CN401)			Check	1.5V or more
	2) REF High SSG frequency: 10MHz +10ppm (10.00001MHz) SSG output: 0dBm							3.5V or less
	3) MOD Low SSG frequency: 10MHz -10ppm (9.99999MHz) SSG output: 0dBm			1.5V or more				
	4) MOD High SSG frequency: 10MHz +10ppm (10.00001MHz) SSG output: 0dBm			3.5V or less				
6. Transmit VCO Lock Voltage (Adjustment)	1) A: Low	DVM	TX	CV	TX	L128	Adjust the interval of the L128. 1.35~1.55V	
	2) B: Low							
7. Receive VCO Lock Voltage (Adjustment)	1) A: Low	DVM	RX	CV1	RX	L28	Adjust the interval of the L28. 1.55~1.60V	Make the adjustments after inserting the insulating tube in the L28 and L30 coils and applying the high frequency varnish.
	2) B: Low					L30	Adjust the interval of the L30. 1.85~1.90V	



## ADJUSTMENT

Item	Condition	Measurement			Adjustment			Specifications / Remarks
		Test-equipment	Unit	Terminal	Unit	Parts	Method	
8. Fixation of Oscillation Coil	1) Apply the high-frequency varnish to the adjusted Transmit VCO coil (L128, L108) and cover it with a shield cover. 2) Apply the high-frequency varnish to the adjusted Receive VCO coil (L28, L30) and cover it with a shield cover.							
9. Transmit VCO Lock Voltage (Check)	1) A: High	DVM	TX	CV			Check	3.6~4.2V
	2) B: High							
10. Receive VCO Lock Voltage (Check)	1) A: Low	DVM PC	RX	CV1			Check	0.9V or more
	2) A: High							4.40V or less
	3) B: Low							1.00V or more
	4) B: High							4.3V or less
11. Reference Signal  The switching circuit to switch the OCXO and the internal reference oscillation	1) Connecting SSG to REF IN and 50Ω-load parallel. SSG frequency: 10MHz SSG output: +0dBm (224mV)	SSG Spectrum analyzer	Rear TX	REF IN REF OUT	TX	VR402	+8~+9dBm	The OCXO LED (orange) lights.
	2) SSG frequency: 10MHz SSG output: +0dBm (224mV)	SSG Oscilloscope	Rear TX	REF IN REF_LV		VR401	2.0Vp-p	The OCXO LED (green) lights.
	3) SSG frequency: 10MHz SSG output: +10dBm (708mV)	SSG Spectrum analyzer	Rear TX	REF IN REF OUT		Check	REF OUT: +10dBm or less The OCXO LED (orange) lights.	
	4) SSG frequency: 10MHz SSG output: -7dBm (99.9mV)						REF OUT: -50dBm or less The OCXO LED goes off.	
12. VCXO	1) Confirm that there is no OCXO and external reference input.	F. counter PC	TX	REF_IN (CN808)		PC ADJ	5.99MHz+0.3ppm	±0.15ppm (5.99000270~5.99000090MHz) It takes a time from movement of adjustment value to stability.
13. Maximum Deviation (NXDN)	1) NXDN Narrow					PC ADJ	Value: 22800	Fixed value writing
	2) NXDN Very Narrow						Value: 10000	
14. Driver Amplifier Power	Disconnect the cable from TX OUT and insert a cable from power meter. After the adjustment, connect the cable to TX OUT. 1) Low 2) Center 3) High	Power meter	TX	TX OUT (CN802)		PC ADJ	+18dBm (63mW)	±0.1dB  Disconnect the cable from TX OUT and insert a cable from power meter. After the adjustment, connect the cable to TX OUT.

## ADJUSTMENT

Item	Condition	Measurement			Adjustment			Specifications / Remarks
		Test-equipment	Unit	Terminal	Unit	Parts	Method	
15. High Transmit Power (Pre ADJ)	1) Center	Power meter PC	Rear	TX ANT		PC ADJ	Value: 1024	Fixed value writing
					Final	VR2	25.0W	±0.5W
16. Coupler ADJ	1) Low	DVM	Final	REF	Final	VR1	Adjust to the minimum value.	
17. High Transmit Power (Max power limit ADJ)	1) High	Power meter PC	Rear	TX ANT		PC ADJ	Value: 1024	Fixed value writing
					Final	VR2	30.0W	±1.0W
18. High Transmit Power	Frequency 1) Low 2) Center 3) High Attach the EXCITER/FINAL shield cover.	Power meter Ammeter	Rear	TX ANT		PC ADJ	25.0W	±0.5W 10.0A or less
							5.0W	±0.1W 5.5A or less
19. Low Transmit Power	Frequency 1) Low 2) Center 3) High Attach the EXCITER/FINAL shield cover.							
20. Deviation  (The transmission VCO band is separated into A and B. 3-points for each, i.e., total of 6-points shall be adjusted.)	Modulation pattern : 100Hz square signal Connect the deviation meter to the TX ANT end via the ATT. Deviation meter setting HPF: OFF LPF: 15kHz De-emp: OFF Detector: (p-p)/2 1) A: Low 2) A: Center 3) A: High 4) B: Low 5) B: Center 6) B: High	Deviation meter Oscilloscope PC	Rear	TX ANT		PC ADJ	±1.10kHz Adjust it into clean square wave with changing "Sub-audible Gain" and "Audible Gain".	±0.05kHz  Connect the deviation meter to the TX ANT end via the ATT.
							Check	±3.06kHz±0.20kHz Clean sine wave.

## ADJUSTMENT

Item	Condition	Measurement			Adjustment			Specifications / Remarks
		Test-equipment	Unit	Terminal	Unit	Parts	Method	
21. Maximum Deviation (Analog)	1) Channel: 3 (Center) Wide/Narrow: Analog Wide Connect the deviation meter to the TX ANT end via the ATT. Deviation meter setting HPF: OFF LPF: 15kHz De-emp: OFF Detector: +peak, -peak AG setting: 1kHz/45mVrms (Sine wave, Terminal load)	Deviation meter AG DVM	Rear Front	TX ANT MIC		PC ADJ	±4.1kHz	±0.2kHz  Connect the deviation meter to the TX ANT end via the ATT.
	±1.7kHz						±0.1kHz	
22. Standard Modulation Check	1) Channel: 3 (Center) Wide/Narrow: Analog Wide Connect the deviation meter to the TX ANT end via the ATT. Deviation meter setting HPF: OFF LPF: 15kHz De-emp: OFF Detector: (p-p)/2 AG setting : 1kHz/±3kHz DEV (Sine wave, Terminal load)	Deviation meter AG DVM	Rear Front	TX ANT MIC			Check	4.5mV±1.5mV  Connect the deviation meter to the TX ANT end via the ATT.
	2) Channel: 3 (Center) Wide/Narrow: Analog Narrow Connect the deviation meter to the TX ANT end via the ATT. AG setting : 1kHz/±1.5kHz DEV (Sine wave, Terminal load)						5.5mV±1.5mV	
23. QT Deviation	1) Channel: 3 (Center) Wide/Narrow: Analog Wide Connect the deviation meter to the TX ANT end via the ATT. Deviation meter setting HPF: OFF LPF: 3kHz De-emp: OFF Detector: p-p/2	Deviation meter	Rear	TX ANT		PC ADJ	±0.75kHz	±0.05kHz  Connect the deviation meter to the TX ANT end via the ATT.
	2) Channel: 3 (Center) Wide/Narrow: Analog Narrow						±0.35kHz	±0.05kHz

## ADJUSTMENT

Item	Condition	Measurement			Adjustment			Specifications / Remarks
		Test-equipment	Unit	Terminal	Unit	Parts	Method	
24. DQT Deviation	1) Channel: 3 (Center) Wide/Narrow: Analog Wide Connect the deviation meter to the TX ANT end via the ATT. Deviation meter setting HPF: OFF LPF: 3kHz De-emp: OFF Detector: Peak hold	Deviation meter	Rear	TX ANT		PC ADJ	±0.75kHz	±0.05kHz  Connect the deviation meter to the TX ANT end via the ATT.
	±0.35kHz						±0.05kHz	
25. CW ID Deviation	1) Channel: 3 (Center) Wide/Narrow: Analog Wide Connect the deviation meter to the TX ANT end via the ATT. Deviation meter setting HPF: OFF LPF: 15kHz De-emp: OFF Detector: +peak, -peak	Deviation meter	Rear	TX ANT		PC ADJ	±2.00kHz	±0.05kHz  Connect the deviation meter to the TX ANT end via the ATT.
	±1.00kHz						±0.05kHz	
26. Test Tone Deviation	1) Channel: 3 (Center) Wide/Narrow: Analog Wide Connect the deviation meter to the TX ANT end via the ATT. Deviation meter setting HPF: OFF LPF: 15kHz De-emp: OFF Detector: (p-p)/2	Deviation meter	Rear	TX ANT		PC ADJ	±3.00kHz	±0.05kHz  Connect the deviation meter to the TX ANT end via the ATT.
	±1.50kHz						±0.05kHz	
27. DTMF Deviation	1) Channel: 3 (Center) Wide/Narrow: Analog Wide Connect the deviation meter to the TX ANT end via the ATT. Deviation meter setting HPF: OFF LPF: 15kHz De-emp: OFF Detector: (p-p)/2	Deviation meter	Rear	TX ANT		PC ADJ	±2.85kHz	±0.05kHz  Connect the deviation meter to the TX ANT end via the ATT.
	±1.50kHz						±0.05kHz	

## ADJUSTMENT

Item	Condition	Measurement			Adjustment			Specifications / Remarks
		Test-equipment	Unit	Terminal	Unit	Parts	Method	
28. Courtesy Tone Deviation	1) Channel: 3 (Center) Wide/Narrow: Analog Wide Connect the deviation meter to the TX ANT end via the ATT. Deviation meter setting HPF: OFF LPF: 15kHz De-emp: OFF Detector: (p-p)/2	Deviation meter	Rear	TX ANT		PC ADJ	±1.00kHz	±0.05kHz  Connect the deviation meter to the TX ANT end via the ATT.
	2) Channel: 3 (Center) Wide/Narrow: Analog Narrow						±0.50kHz	±0.05kHz
29. TD Deviation	1) Channel: 3 (Center) Wide/Narrow: Analog Wide Connect the deviation meter to the TX ANT end via the ATT. Deviation meter setting HPF: OFF LPF: 3kHz De-emp: OFF Detector: +peak, -peak AG setting : 0.1kHz/0.5Vp-p (177mVrms)	Deviation meter AG DVM	Rear	TX ANT CONTROL I/O jack TD (pin 8)		PC ADJ	±0.75kHz	±0.02kHz  Connect the deviation meter to the TX ANT end via the ATT.
	2) Channel: 3 (Center) Wide/Narrow: Analog Narrow						±0.75kHz	±0.02kHz
30. Transmit Audio Input (TA)	1) Channel: 3 (Center) Wide/Narrow: Analog Wide Connect the deviation meter to the TX ANT end via the ATT. Deviation meter setting HPF: OFF LPF: 15kHz De-emp: OFF Detector: +peak, -peak AG setting : 1kHz/280mVrms	Deviation meter AG DVM	Rear	TX ANT CONTROL I/O jack TA (pin 9)		PC ADJ	±3.00kHz	±0.03kHz  Connect the deviation meter to the TX ANT end via the ATT.
	2) Channel: 3 (Center) Wide/Narrow: Analog Narrow						±1.50kHz	±0.02kHz
31. BPF	1) Tracking generator Output: -20dBm Spectrum analyzer Frequency: Desired frequency Span: 50MHz	Tracking generator Spectrum analyzer	Rear  RX	RX ANT  CN41	RX	L132 L133 L134 L135	Adjust it by the programmed frequency to look like the wave in figure 1.	Refer to Fig. 1. (Page 30)
32 MCF	1) Wide Tracking generator Output: -20dBm Spectrum analyzer Frequency: 49.95MHz Span: 100kHz	Tracking generator Spectrum analyzer	Rear  RX	CN46  CN47	RX	L46 L52 L74 L90	Adjust it to look like the wave in figure 2.	Refer to Fig. 2. (Page 30)
	2) Narrow Spectrum analyzer Span: 50kHz		L47 L53 L75 L91	Adjust it to look like the wave in figure 3.		Refer to Fig. 3. (Page 30)		

## ADJUSTMENT

Item	Condition	Measurement			Adjustment			Specifications / Remarks
		Test-equipment	Unit	Terminal	Unit	Parts	Method	
33. Discriminator	1) Narrow Frequency: Desired frequency SSG output: -53dBm (501μV) SSG MOD: 1kHz SSG DEV: 1.5kHz AF output: 2V/4Ω	SSG AF V.M	Rear	RX ANT TEST/ SPKR jack SPO (pin 12) 4Ω load	RX	L128	Adjust AF output max.	
34. RD Level	1) Wide/Narrow: Analog Wide Connect the SSG to the RX ANT. SSG setting Frequency: Desired frequency Output: -53dBm (501μV) MOD: 1kHz DEV: ±3.0kHz	SSG AF V.M	Rear	RX ANT CONTROL I/O jack RD (pin 10)		PC ADJ	80mV	±5mV
	2) Wide/Narrow: Analog Narrow SSG setting DEV: ±1.5kHz							
35. RA Level	1) Wide/Narrow: Analog Wide Connect the SSG to the RX ANT. SSG setting Frequency: Desired frequency Output: -53dBm (501μV) MOD: 1kHz DEV: ±3.0kHz	SSG AF V.M	Rear	RX ANT CONTROL I/O jack RA (pin 11)		PC ADJ	400mV	±20mV
	2) Wide/Narrow: Analog Narrow SSG setting DEV: ±1.5kHz							
36. Receiver Sensitivity Check	1) Wide/Narrow: Analog Wide Connect the SSG to the RX ANT. SSG setting Frequency: Desired frequency MOD: 1kHz DEV: ±3.0kHz AF: 0.45V/4Ω	SSG Distortion meter	Rear	RX ANT TEST/ SPKR jack SPO (pin 12) 4Ω load			Check	-115dBm (0.4μV) or less
	2) Wide/Narrow: Analog Narrow SSG setting DEV: ±1.5kHz							
37. Tight Squelch	1) Wide/Narrow: Analog Wide Connect the SSG to the RX ANT. SSG setting Frequency: Desired frequency Output: 12dB SINAD level +7dB MOD: 1kHz DEV: ±3.0kHz	SSG Oscilloscope Audio analyzer	Rear	RX ANT TEST/ SPKR jack SPO (pin 12) 4Ω load		PC ADJ	Adjust it to the level to open the squelch.	
	2) SSG output: OFF						Check	The squelch shall be closed.
	3) Wide/Narrow: Analog Narrow SSG setting DEV: ±1.5kHz					PC ADJ	Adjust it to the level to open the squelch.	
	4) SSG output: OFF					Check	The squelch shall be closed.	

## ADJUSTMENT

Item	Condition	Measurement			Adjustment			Specifications / Remarks	
		Test-equipment	Unit	Terminal	Unit	Parts	Method		
38. Open Squelch	1) Wide/Narrow: Analog Wide Connect the SSG to the RX ANT. SSG setting Frequency: Desired frequency Output: 12dB SINAD level -2dB MOD: 1kHz DEV: ±3.0kHz	SSG Oscilloscope Audio analyzer	Rear	RX ANT TEST/ SPKR jack SPO (pin 12) 4Ω load		PC ADJ	Adjust it to the level to open the squelch.		
	2) SSG output: OFF						Check	The squelch shall be closed.	
	3) Wide/Narrow: Analog Narrow SSG setting DEV: ±1.5kHz						PC ADJ	Adjust it to the level to open the squelch.	
	4) SSG output: OFF						Check	The squelch shall be closed.	
39. RSSI	Wide/Narrow: Analog Narrow Connect the SSG to the RX ANT. SSG setting Frequency: Desired frequency MOD: 1kHz DEV: ±1.5kHz 1) SSG output: -53dBm (501μV)	SSG AF V.M	Rear	RX ANT TEST/ SPKR jack RSSI (pin 8)		PC ADJ	3.5V	±0.1V	
	2) Point: High Level SSG output : 12dB SINAD level +7dB						Import the value to a PC.		
	3) Point: Low Level SSG output : 12dB SINAD level -2dB								
40. Repeater Gain	1) Wide/Narrow: Analog Wide Connect the SSG to the RX ANT. SSG setting Frequency: Desired frequency Output: -53dBm (501μV) MOD: 1.0kHz DEV: ±1.0kHz Connect the deviation meter to the TX ANT end via the ATT. Deviation meter setting HPF: OFF LPF: 15kHz De-emp: OFF Detector: +peak, -peak	SSG Deviation meter	Rear	RX ANT TX ANT		PC ADJ	±1.00kHz	±0.10kHz	
	2) Wide/Narrow: Analog Narrow						±1.00kHz	±0.10kHz	

# NXR-800 PC BOARD

## FINAL UNIT (X45-3862-71) Component side view (J79-0290-19)

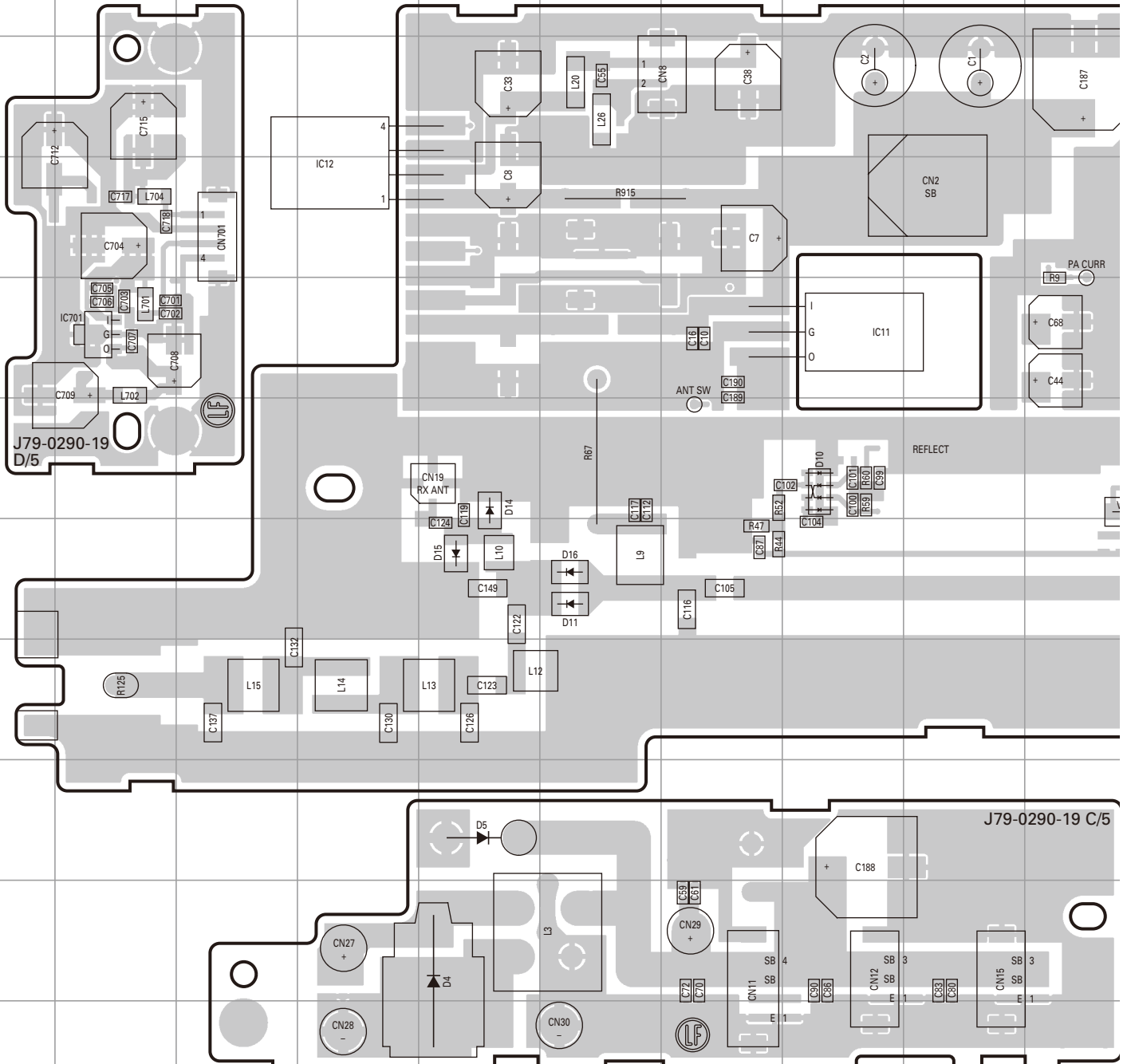

Ref. No.	Address	Ref. No.	Address	Ref. No.	Address	Ref. No.	Address	Ref. No.	Address
IC2	4O	IC8	5M	IC701	5B	D5	9E	D14	6E
IC4	5K	IC9	3M	Q2	4Q	D7	4Q	D15	7E
IC5	4M	IC10	5R	Q6	3N	D9	6O	D16	7F
IC6	4K	IC11	5H	Q8	5N	D10	6H		
IC7	5N	IC12	4D	D4	10E	D11	7F		



# PC BOARD NXR-800

## FINAL UNIT (X45-3862-71) Component side view (J79-0290-19)

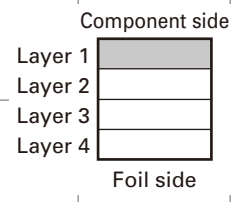
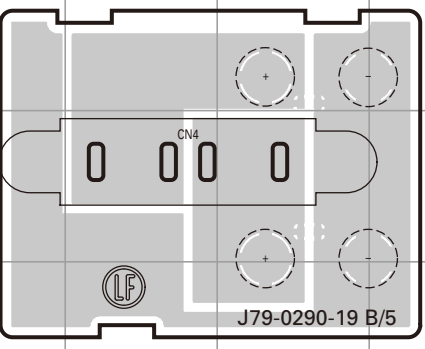
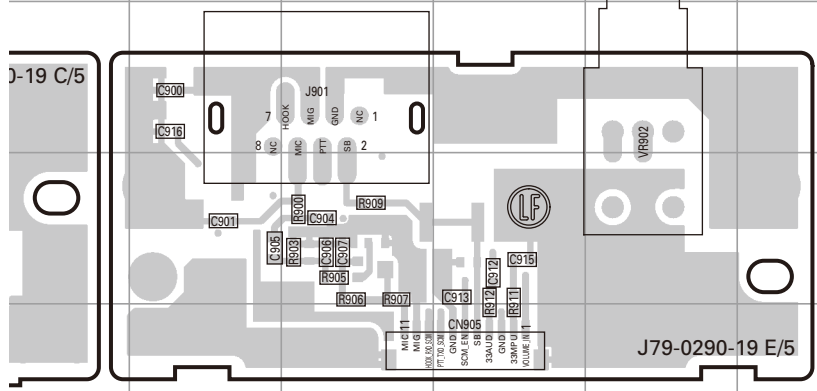
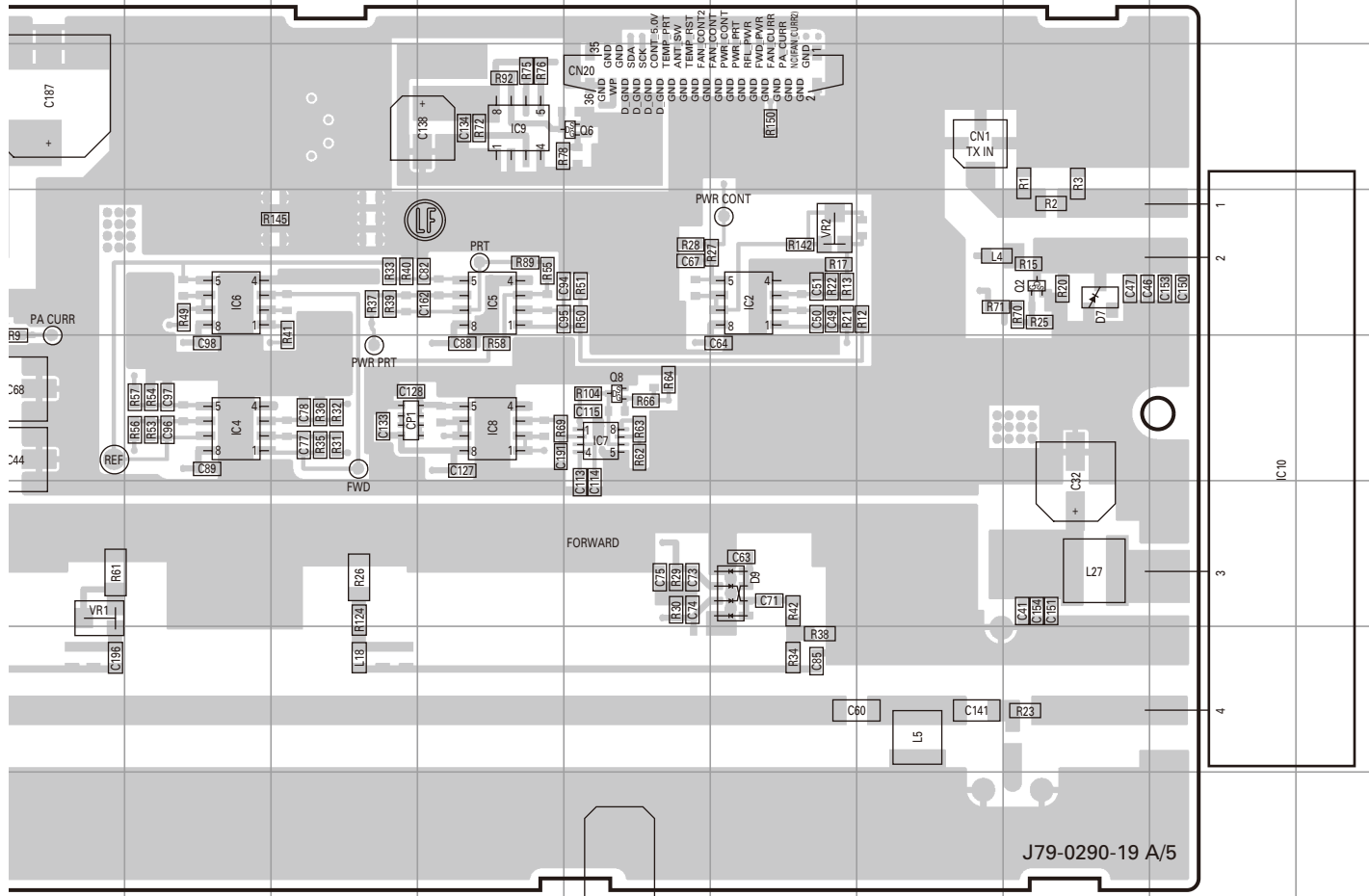

# NXR-800 PC BOARD

**FINAL UNIT (X45-3862-71)**  
**Foil side view (J79-0290-19)**

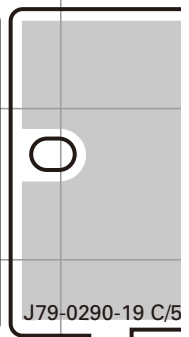
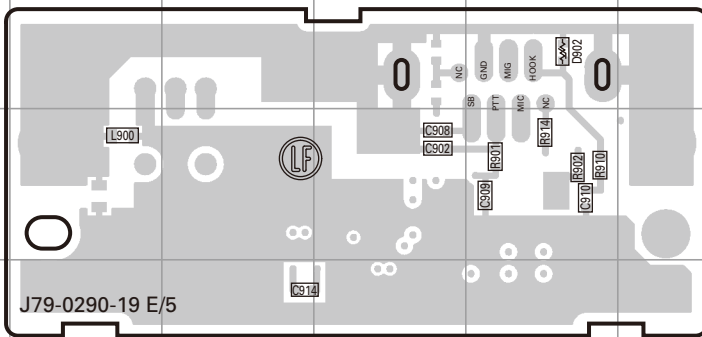
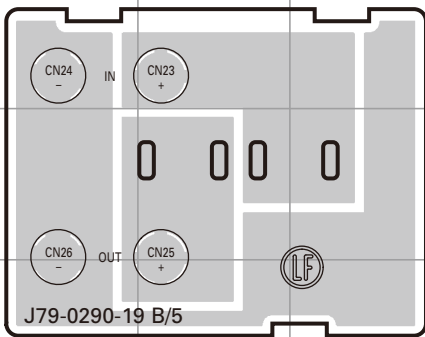
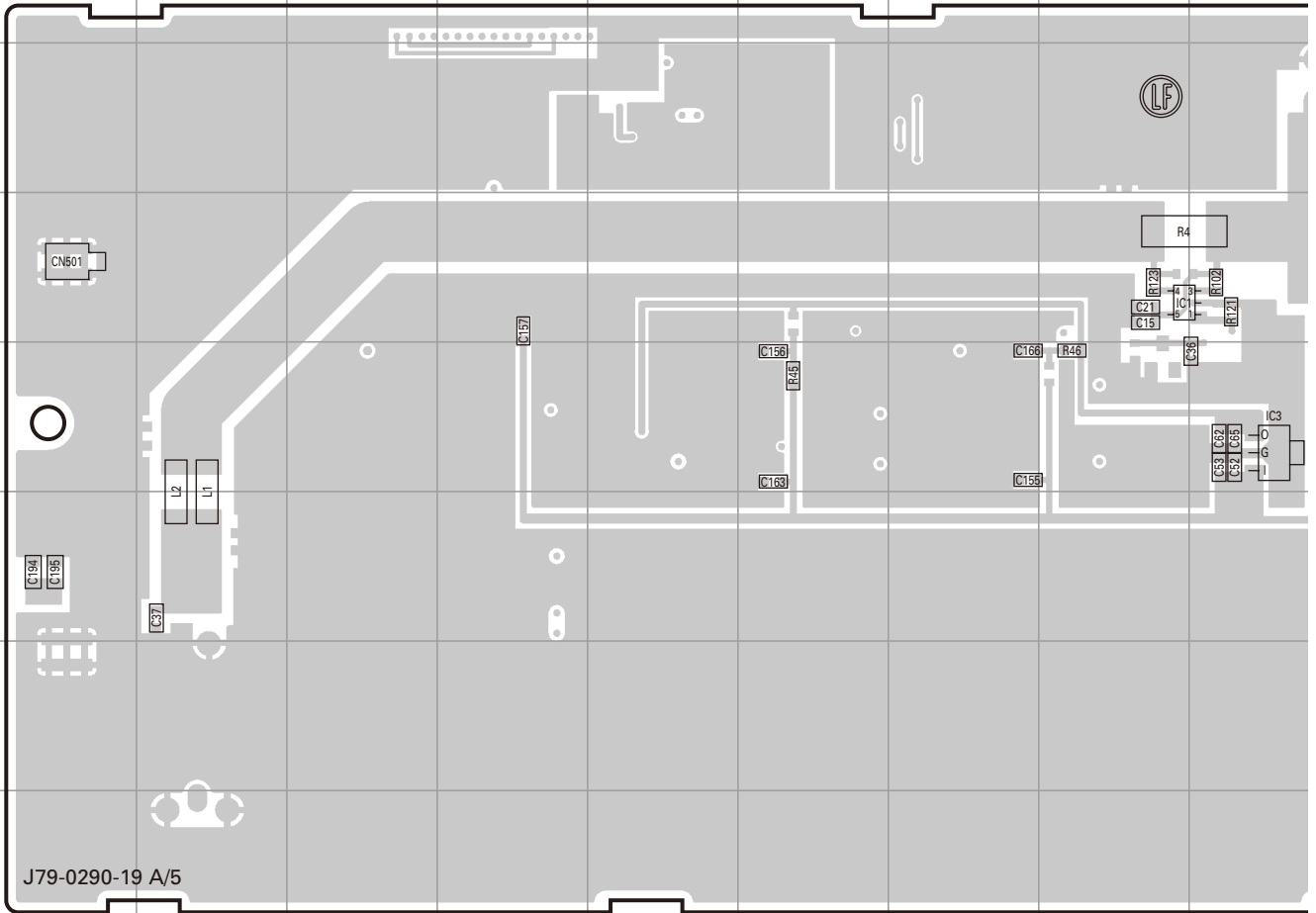

Ref. No.	Address	Ref. No.	Address
IC1	4I	Q4	5M
IC3	5J	Q5	5L
IC702	5Q	D6	3N
IC703	4Q	D902	9H

# PC BOARD NXR-800

**FINAL UNIT (X45-3862-71)**  
**Foil side view (J79-0290-19)**

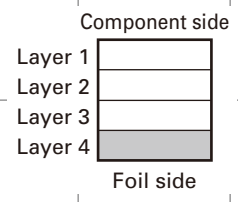
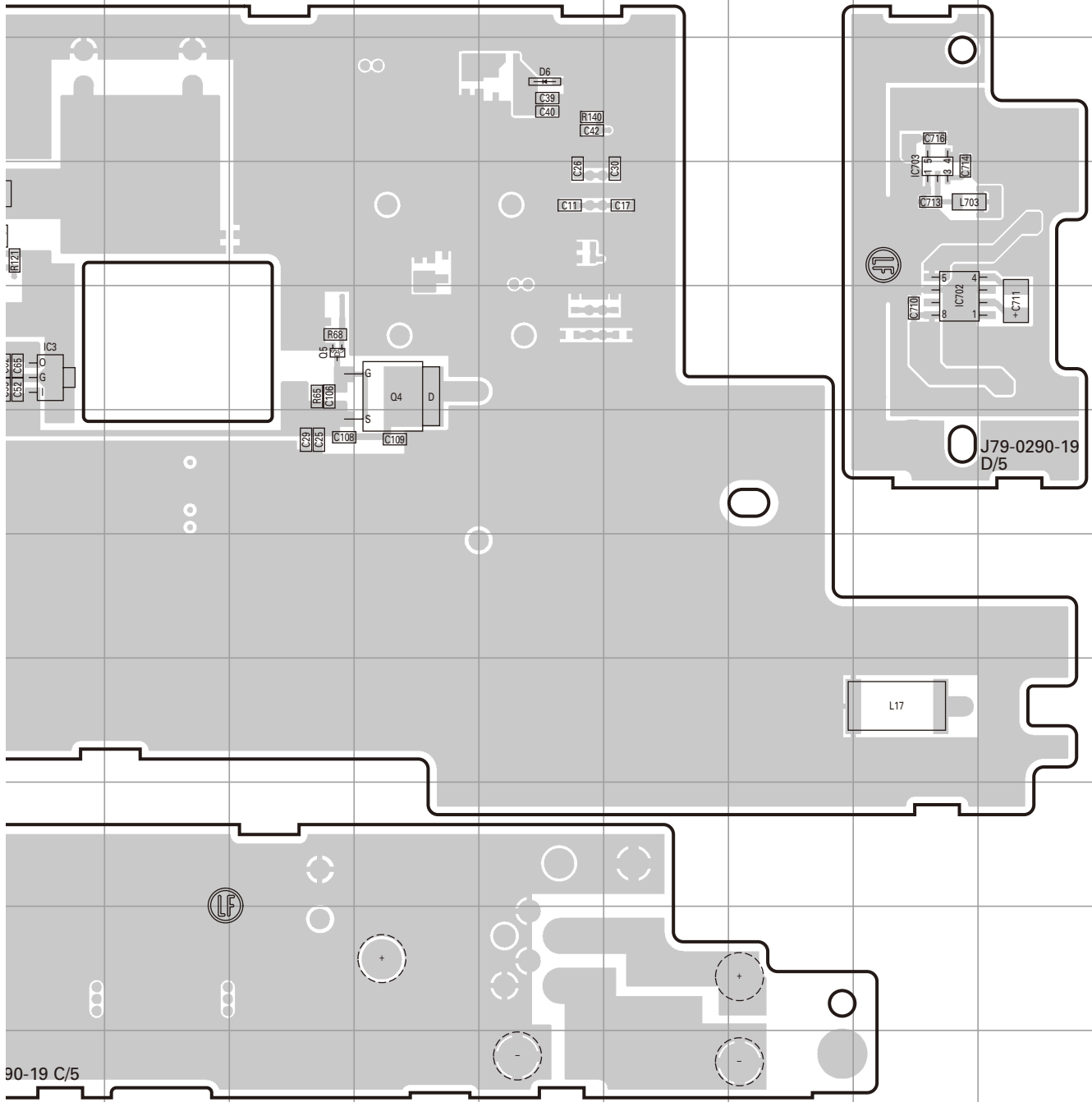

# NXR-800 PC BOARD

**RX UNIT (X55-3102-72)**  
**Component side view (J79-0292-09)**

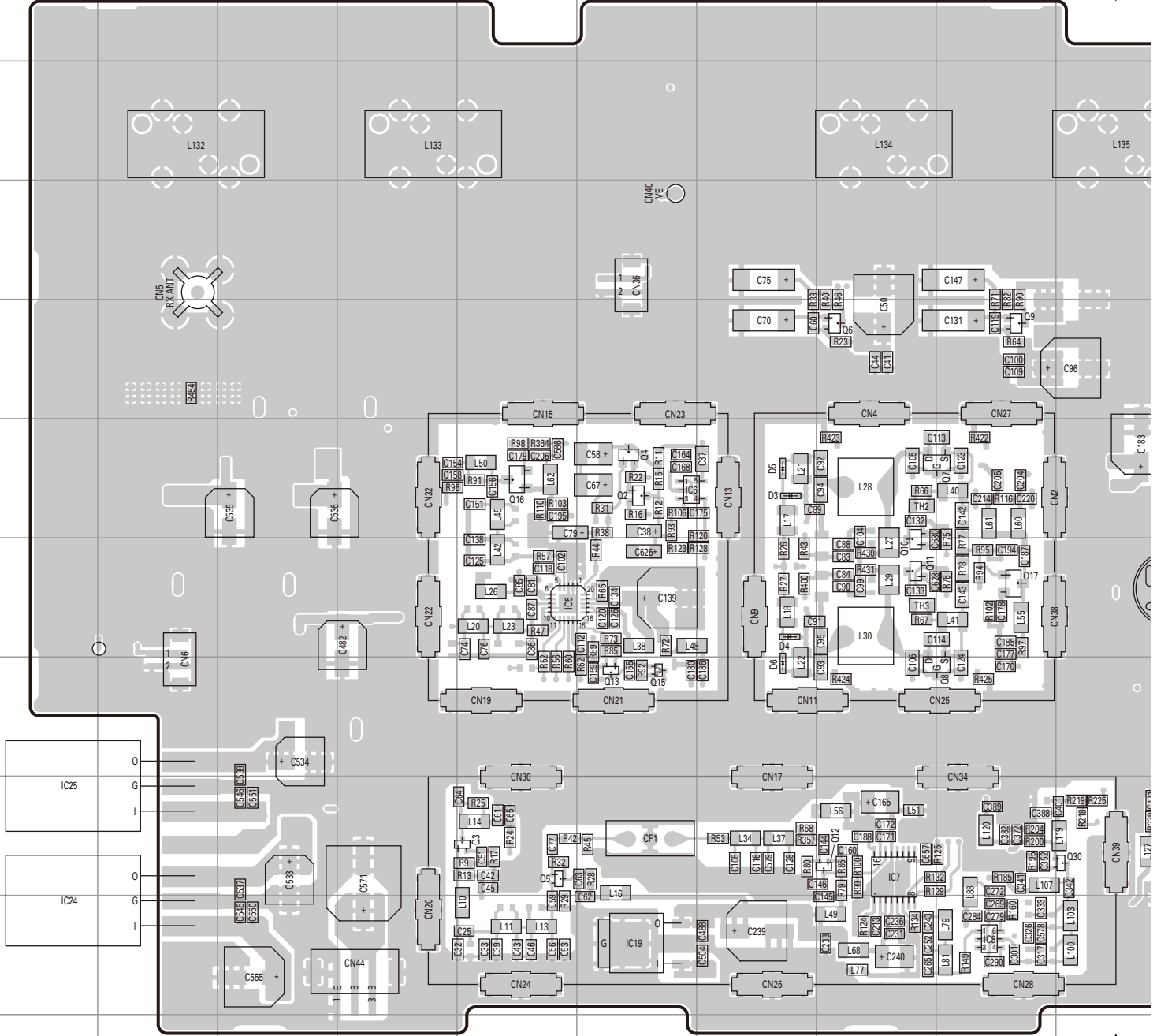

Ref. No.	Address	Ref. No.	Address	Ref. No.	Address	Ref. No.	Address	Ref. No.	Address	Ref. No.	Address	Ref. No.	Address	Ref. No.	Address
IC5	7E	IC15	5K	IC30	8M	Q7	6I	Q17	7I	Q35	6N	D5	6G	D18	8M
IC6	6F	IC19	10F	IC31	9M	Q8	8I	Q22	6O	Q37	7N	D6	8G	D19	6L
IC7	9H	IC20	8K	IC32	8L	Q9	5I	Q24	10O	Q38	6P	D11	8N	D20	6L
IC8	10I	IC22	10Q	IC35	8M	Q10	7H	Q27	9P	Q39	9J	D12	9N	D21	9L
IC10	9Q	IC23	9K	Q2	6F	Q11	7H	Q28	6Q	Q40	7M	D13	7R		
IC11	6O	IC24	10A	Q3	9E	Q12	9H	Q29	5S	Q51	10M	D14	6R		
IC12	7M	IC25	9A	Q4	6F	Q13	8F	Q30	9J	Q56	10L	D15	6M		
IC13	9S	IC28	8N	Q5	9E	Q15	8F	Q33	9P	D3	6G	D16	6M		
IC14	9R	IC29	8L	Q6	5H	Q16	6E	Q34	7N	D4	7G	D17	8M		

# PC BOARD NXR-800

RX UNIT (X55-3102-72)  
Component side view (J79-0292-09)

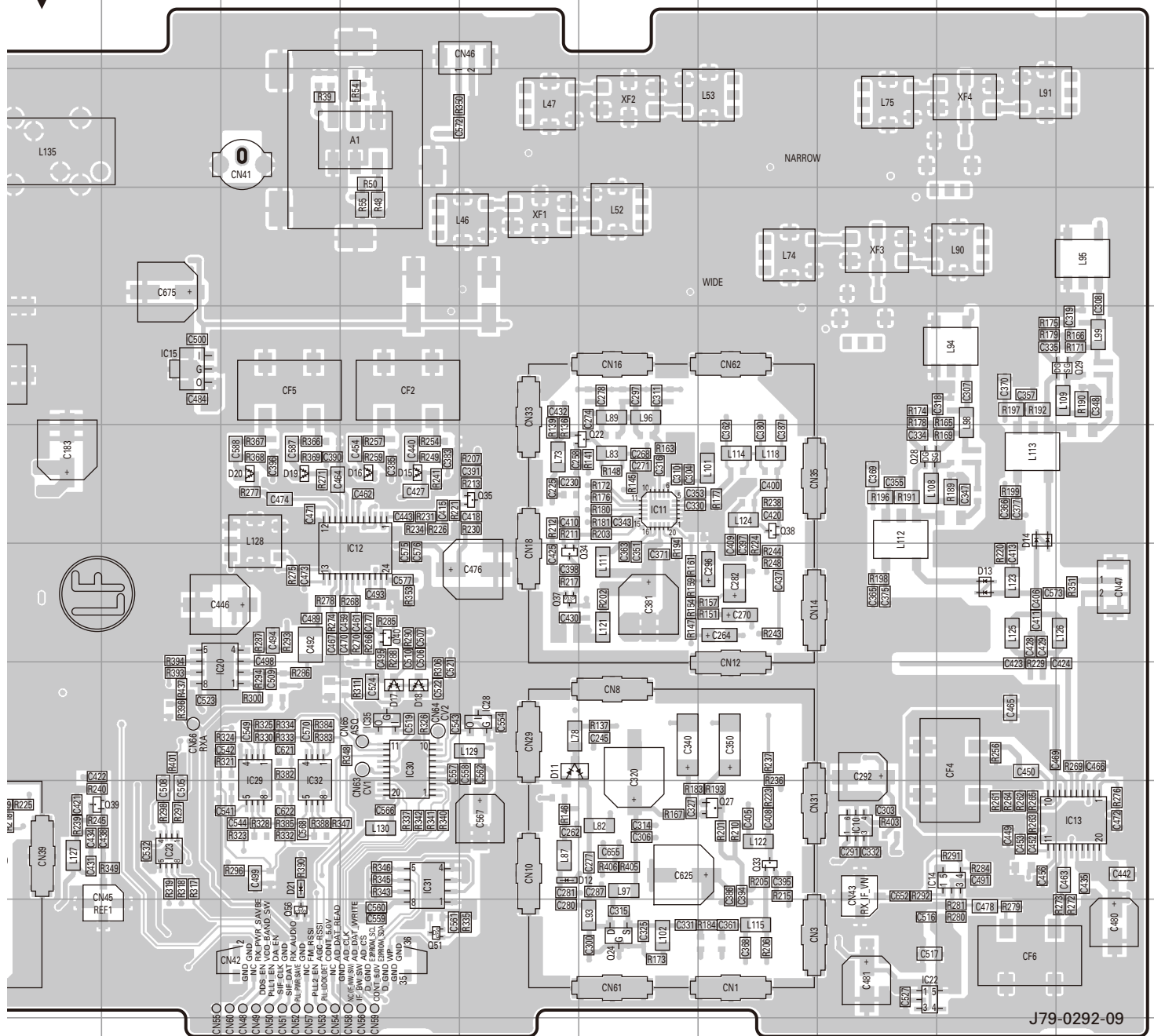

Component side

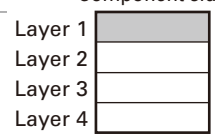

# NXR-800 PC BOARD

RX UNIT (X55-3102-72)  
Foil side view (J79-0292-09)

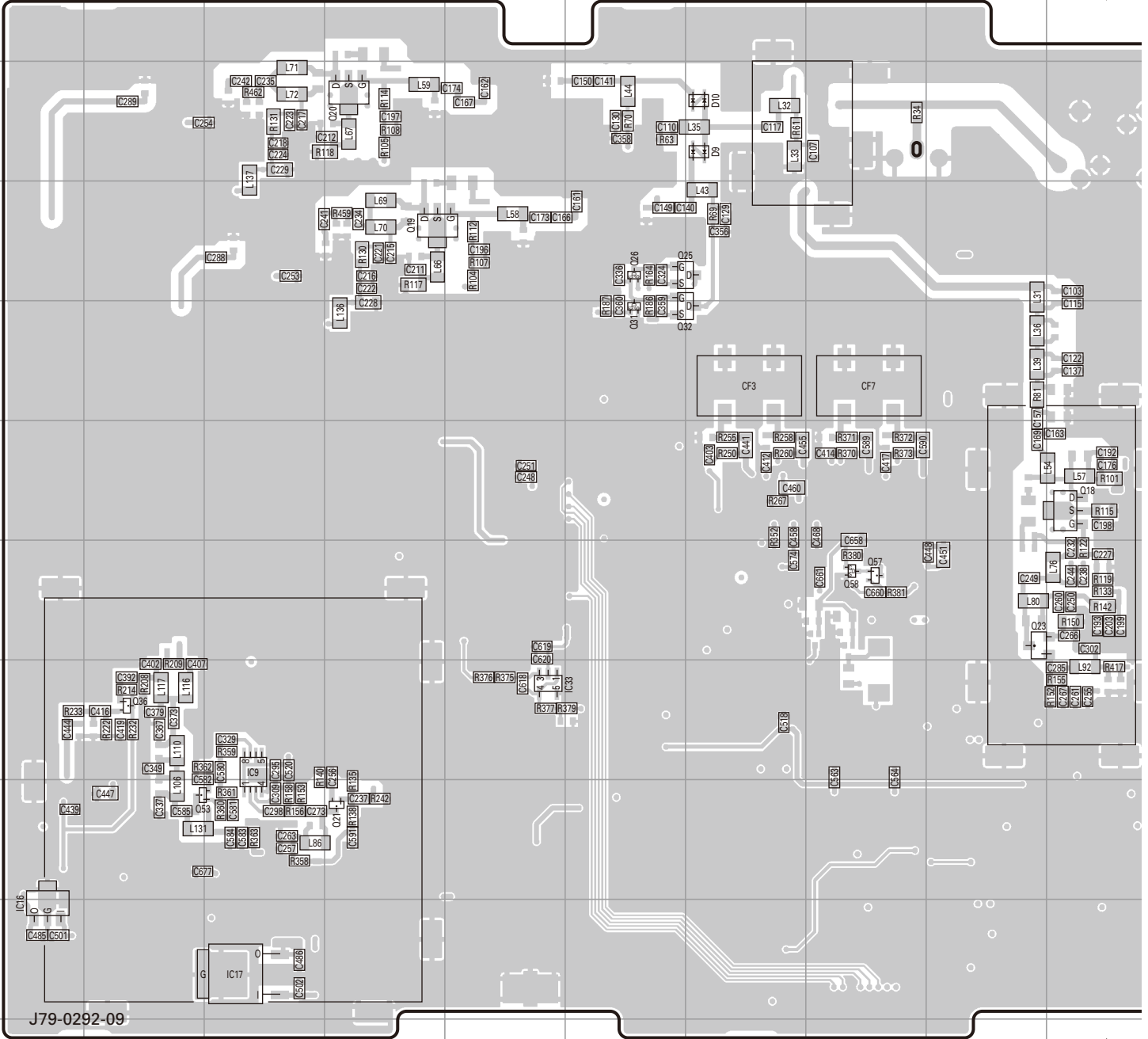

Ref. No.	Address	Ref. No.	Address	Ref. No.	Address	Ref. No.	Address
IC4	4M	Q14	7L	Q32	5G	Q61	7N
IC9	8C	Q18	6J	Q36	8B	D1	4N
IC16	10A	Q19	4D	Q50	10Q	D2	4N
IC17	10C	Q20	3D	Q52	10Q	D9	3G
IC18	8P	Q21	9D	Q53	9B	D10	3G
IC26	7Q	Q23	7I	Q57	7H		
IC27	7P	Q25	4G	Q58	7H		
IC33	8E	Q26	4F	Q59	7L		
Q1	3N	Q31	5F	Q60	7N		

# PC BOARD NXR-800

RX UNIT (X55-3102-72)  
Foil side view (J79-0292-09)

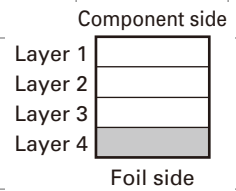
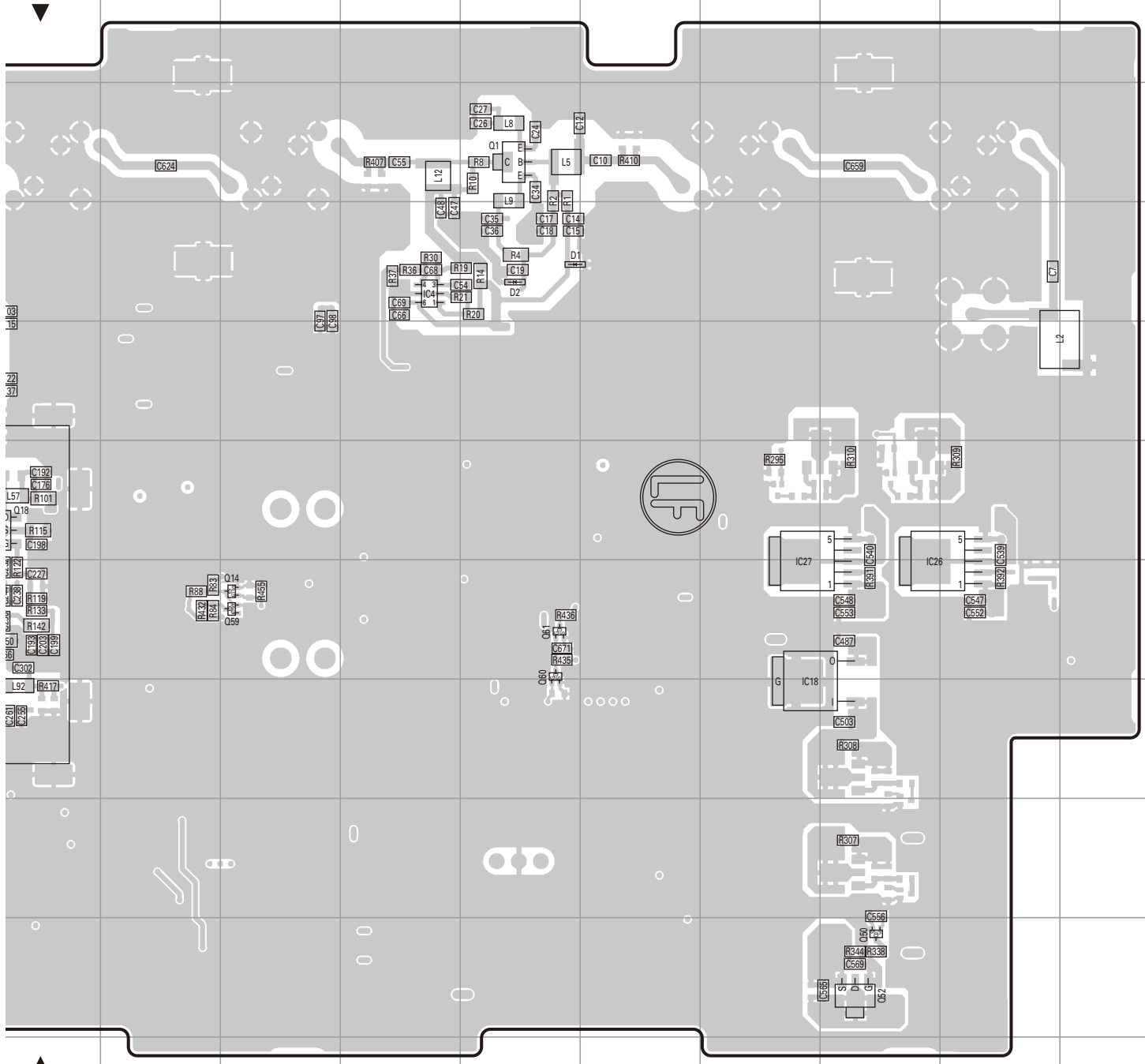

# NXR-800 PC BOARD

TX UNIT (X56-3120-12)  
Component side view (J79-0153-09)

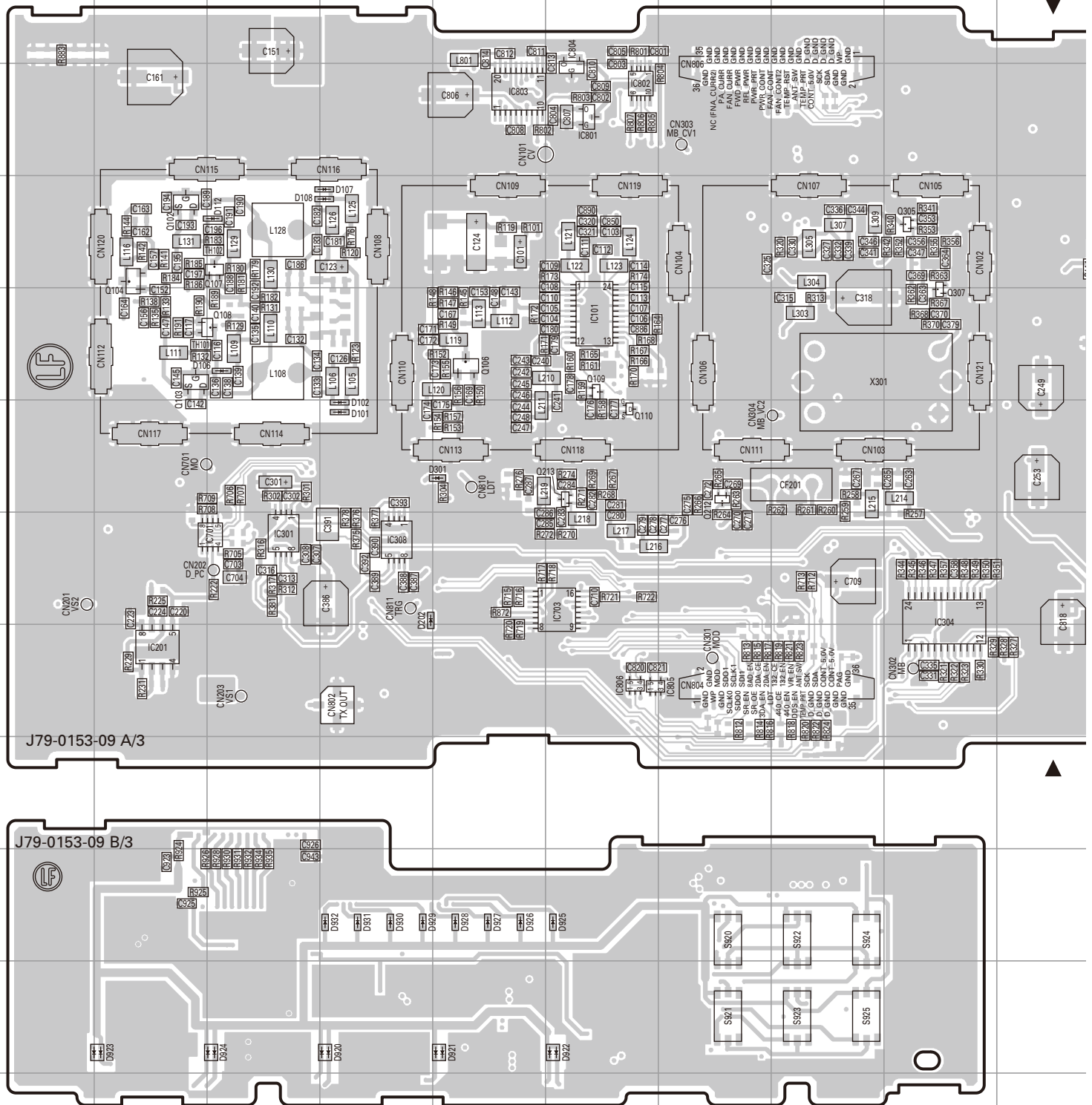

J79-0153-09 A/3

J79-0153-09 B/3

Ref. No.	Address	Ref. No.	Address	Ref. No.	Address	Ref. No.	Address	Ref. No.	Address	Ref. No.	Address	Ref. No.	Address	Ref. No.	Address
IC101	5F	IC706	6K	IC807	8K	Q104	4B	Q213	6F	Q964	11O	D107	4D	D922	11F
IC201	8B	IC801	3F	IC808	4S	Q106	5E	Q305	4I	Q965	11P	D108	4D	D923	11B
IC301	7C	IC802	3F	IC809	3S	Q107	4C	Q307	5I	Q966	11Q	D112	4C	D924	11C
IC304	7I	IC803	3E	IC960	11R	Q108	5C	Q401	4K	Q967	11Q	D202	7D	D925	10F
IC308	7D	IC804	3F	IC961	11P	Q109	5F	Q402	4K	D101	6D	D301	6E	D926	10E
IC701	7C	IC805	8F	Q102	4B	Q110	6F	Q962	11R	D102	6D	D920	11D	D927	10E
IC703	7F	IC806	8F	Q103	5B	Q212	6G	Q963	11R	D106	5C	D921	11E	D928	10E



# PC BOARD NXR-800

## TX UNIT (X56-3120-12) Component side view (J79-0153-09)

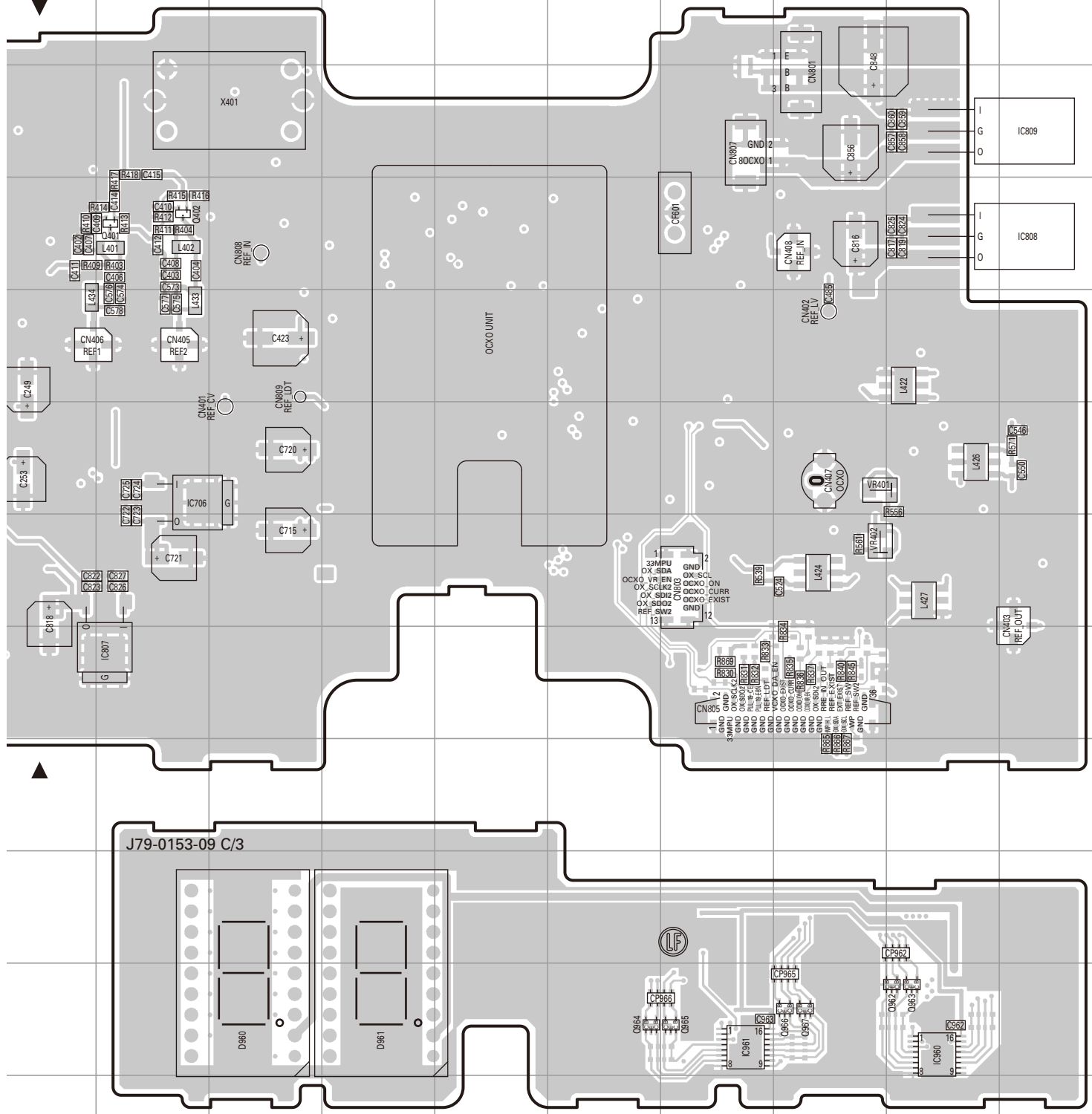

No.	Address
29	10D
30	10D
31	10D
32	10D
60	11L
61	11M

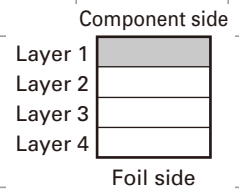

# NXR-800 PC BOARD

**TX UNIT (X56-3120-12)**  
**Foil side view (J79-0153-09)**

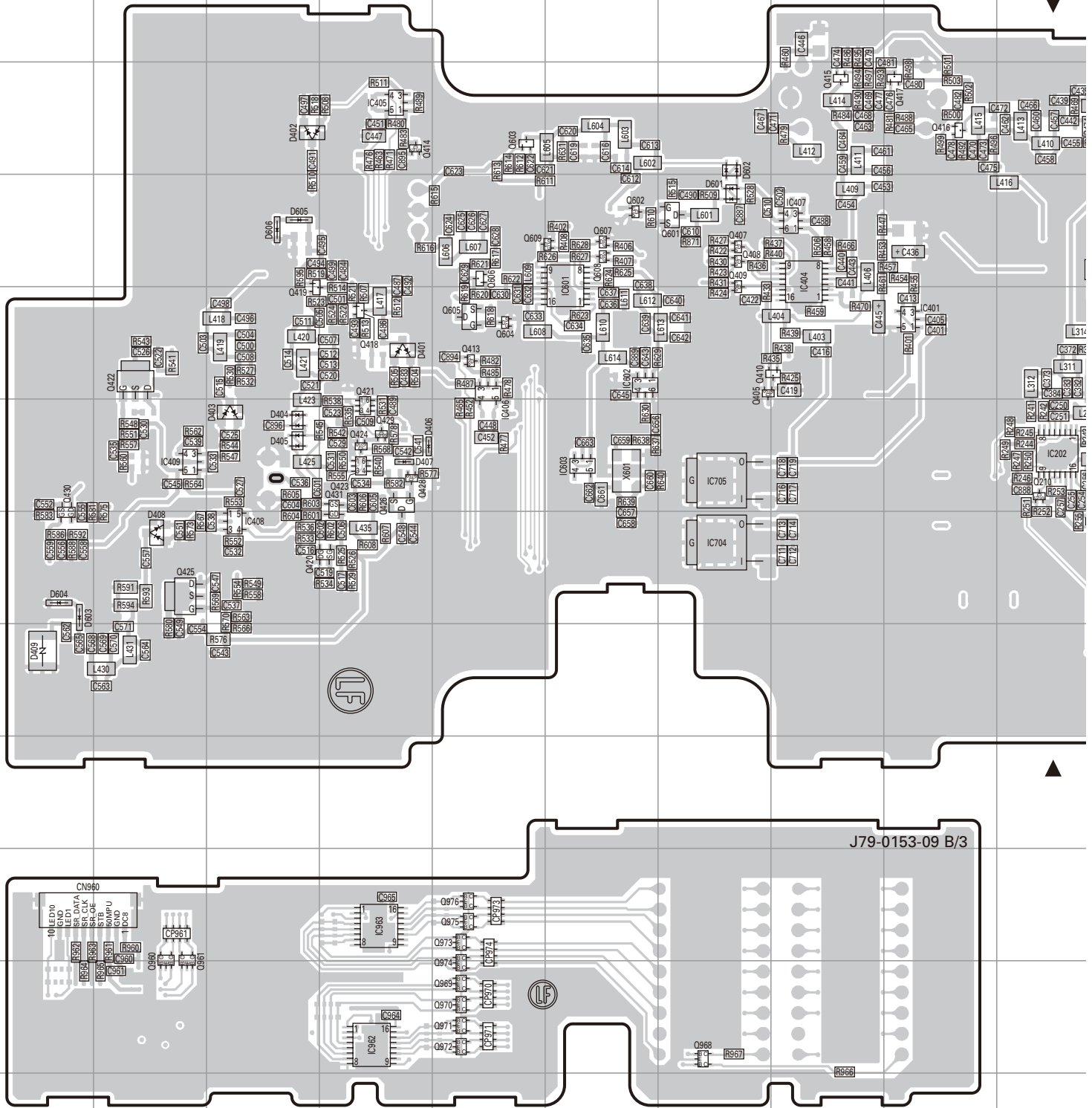

J79-0153-09 B/3

IC102	4O	IC404	4H	IC702	7L	IC926	11L	Q205	8P	Q407	4G	Q417	3I	Q426	6D	Q605	5E
IC104	2Q	IC405	3D	IC704	7G	IC962	11D	Q206	7P	Q408	4G	Q418	5D	Q428	6D	Q606	4E
IC202	6J	IC406	5E	IC705	6G	IC963	10D	Q210	6J	Q409	4G	Q419	5C	Q429	6D	Q607	4F
IC302	4M	IC407	4H	IC920	11O	Q101	4R	Q211	7J	Q410	5H	Q420	7D	Q430	6A	Q608	4F
IC303	4L	IC408	7C	IC921	11O	Q105	3R	Q301	5L	Q412	3J	Q421	6D	Q431	6D	Q609	4F
IC305	5M	IC409	6B	IC922	11O	Q201	6S	Q302	6O	Q413	5E	Q422	5B	Q601	4G	Q701	8L
IC306	4M	IC601	4F	IC923	11N	Q202	7S	Q303	4L	Q414	3D	Q423	6D	Q602	4F	Q702	4R
IC307	5K	IC602	5F	IC924	11Q	Q203	8Q	Q304	4K	Q415	3H	Q424	6D	Q603	3E	Q920	11N
IC401	5I	IC603	6F	IC925	11P	Q204	7P	Q405	5G	Q416	3I	Q425	7B	Q604	5E	Q921	11C

# PC BOARD NXR-800

TX UNIT (X56-3120-12)

Foil side view (J79-0153-09)

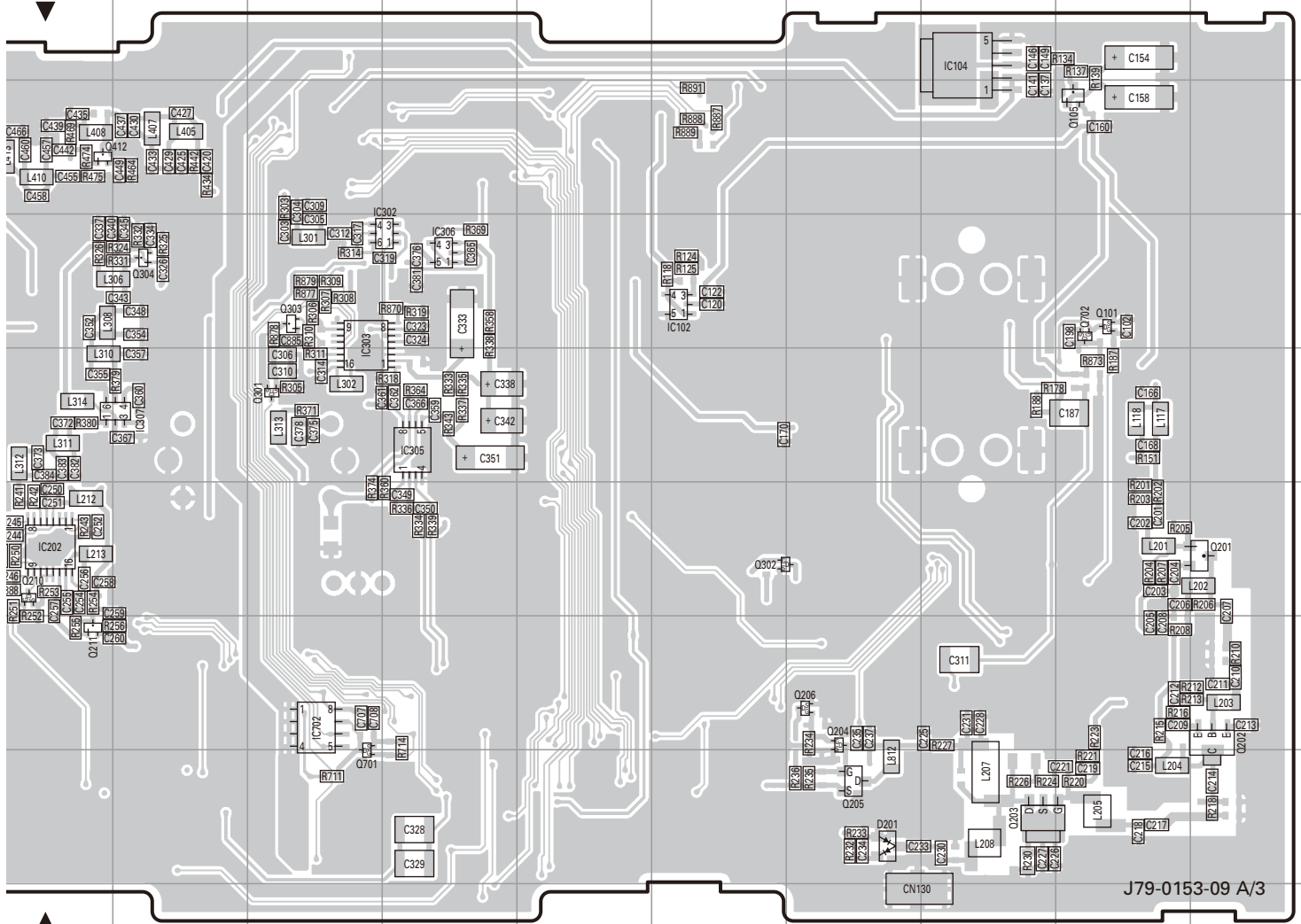

J79-0153-09 A/3

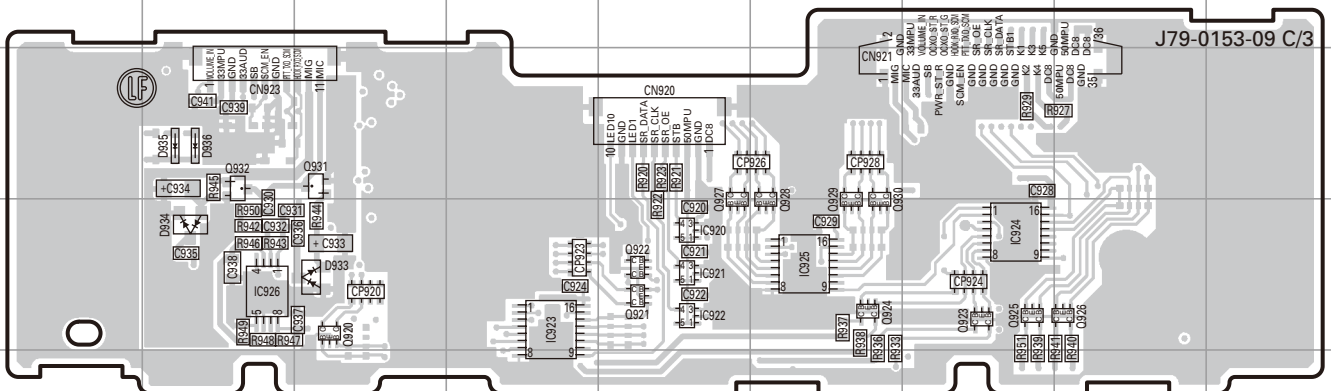

J79-0153-09 C/3

No.	Address	Ref. No.	Address	Ref. No.	Address	Ref. No.	Address	Ref. No.	Address	Ref. No.	Address
05	5E	Q922	11O	Q931	10M	Q973	10E	D405	6C	D605	4C
06	4E	Q923	11Q	Q932	10L	Q974	11E	D406	6D	D606	4C
07	4F	Q924	11P	Q960	10B	Q975	10E	D407	6D	D933	11M
08	4F	Q925	11Q	Q961	10B	Q976	10E	D408	7B	D934	11L
09	4F	Q926	11R	Q968	11G	D201	8P	D409	8A	D935	10L
01	8L	Q927	11O	Q969	11E	D401	5D	D601	4G	D936	10L
02	4R	Q928	11P	Q970	11E	D402	3C	D602	3G		
20	11M	Q929	11P	Q971	11E	D403	6C	D603	7A		
21	11O	Q930	11P	Q972	11E	D404	6C	D604	7A		

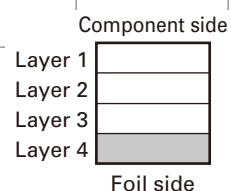

# NXR-800 SCHEMATIC DIAGRAM

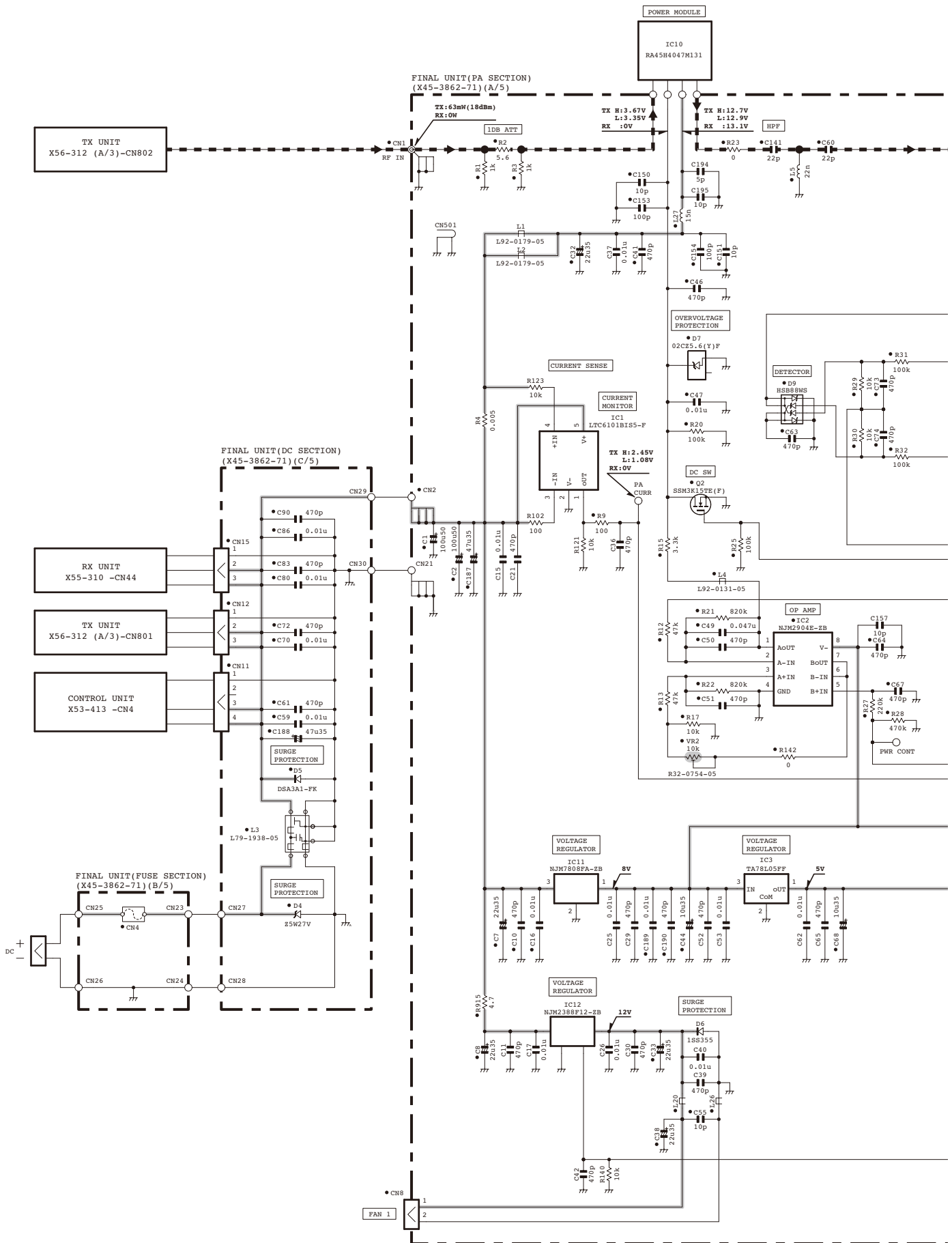

# SCHEMATIC DIAGRAM NXR-800

FINAL UNIT (PA SECTION)  
(X45-3862-71) (A/5)

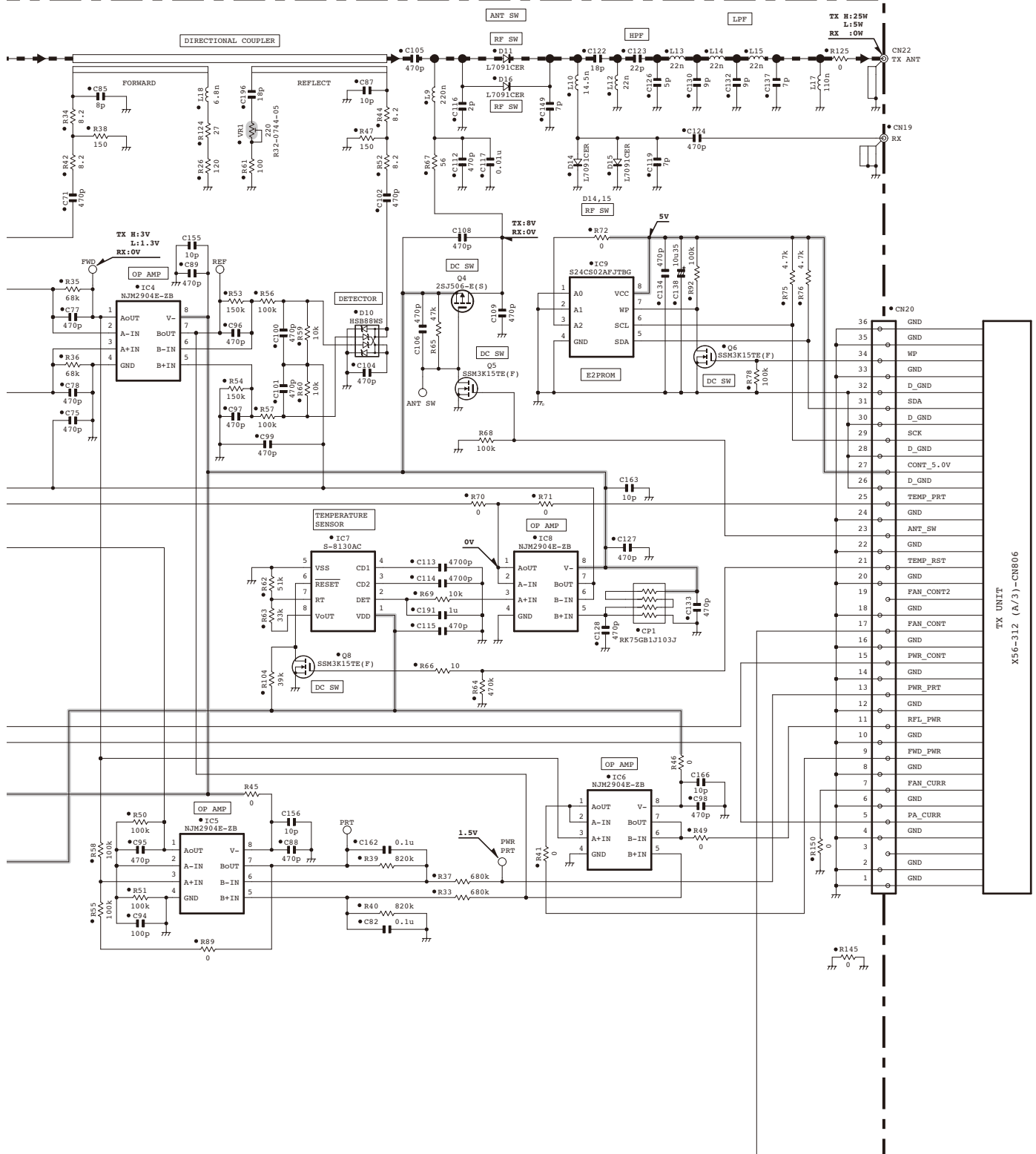

Note : The components marked with a dot (•) are parts of layer 1.

# NXR-800 SCHEMATIC DIAGRAM

RX UNIT (X55-3102-72)

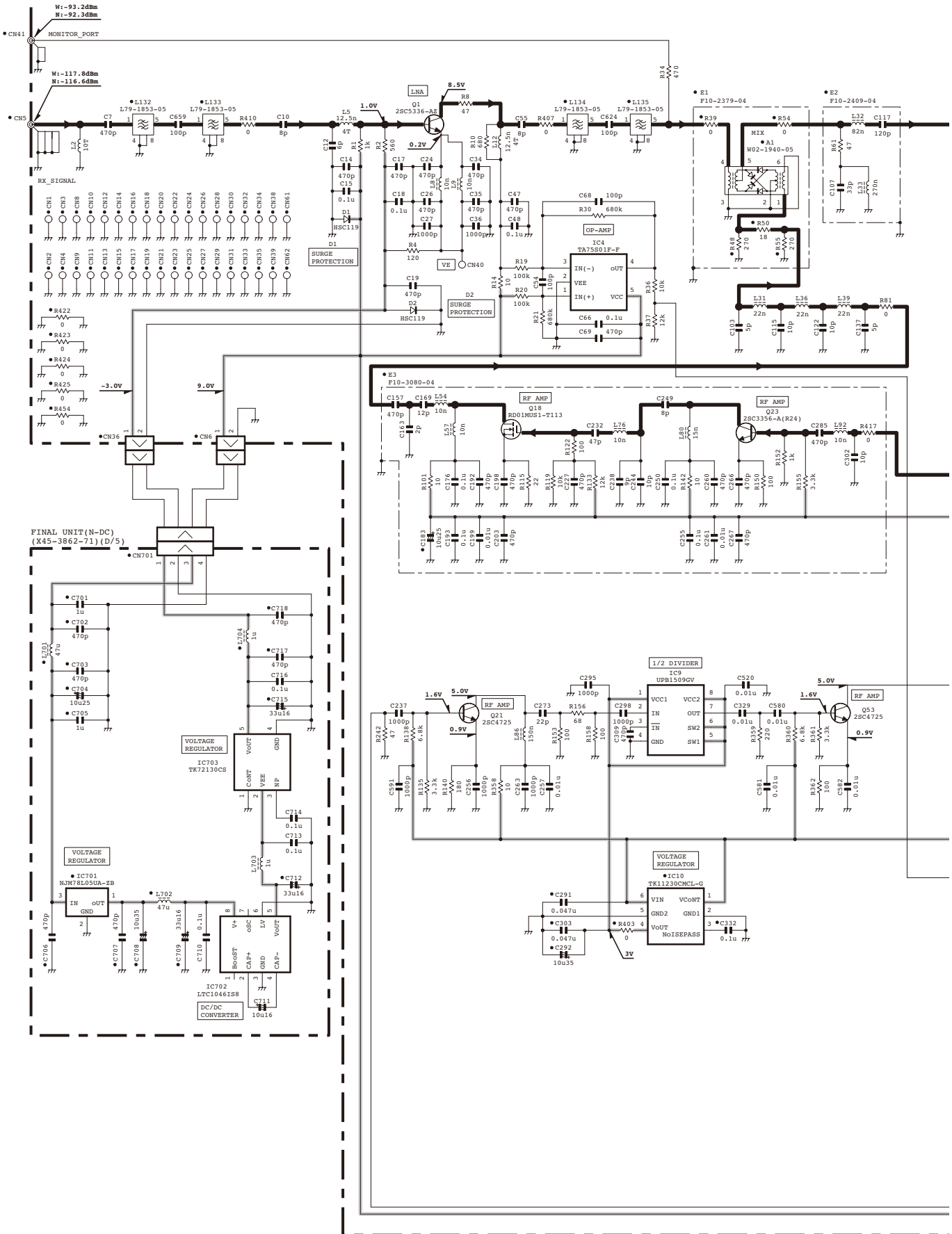

# SCHEMATIC DIAGRAM NXR-800

RX UNIT (X55-3102-72)

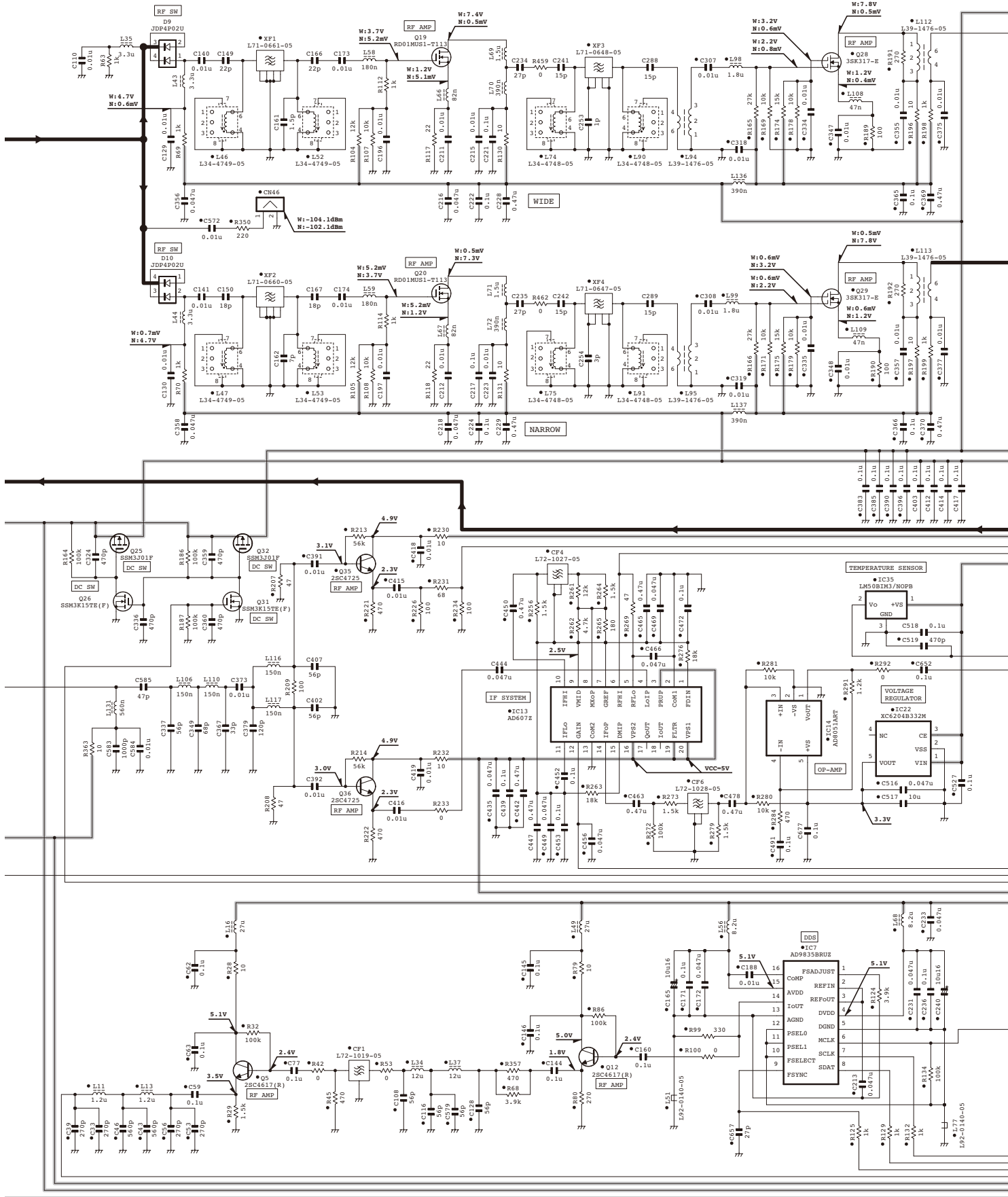



# NXR-800 SCHEMATIC DIAGRAM

RX UNIT (X55-3102-72)

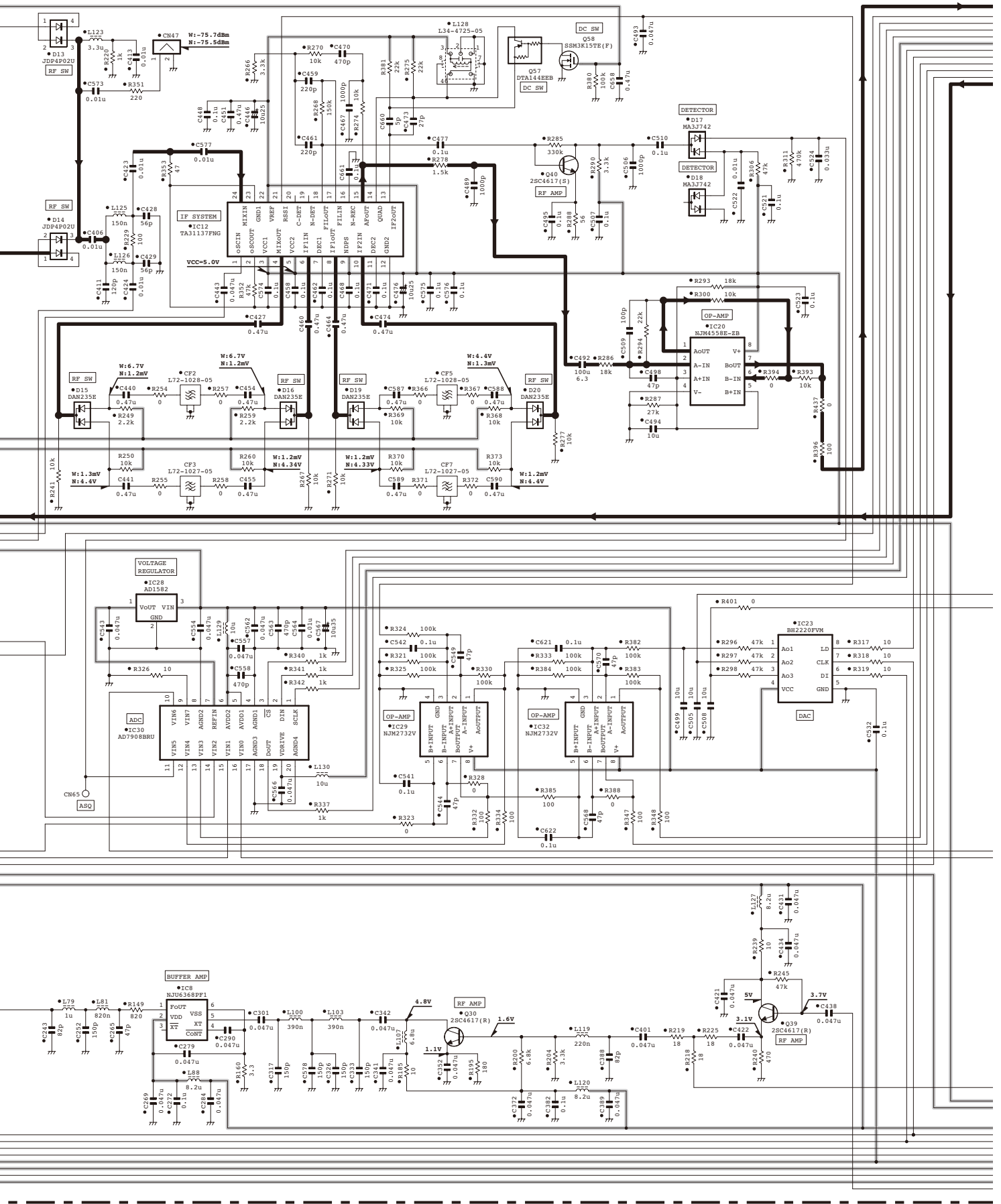



# SCHEMATIC DIAGRAM NXR-800

RX UNIT (X55-3102-72)

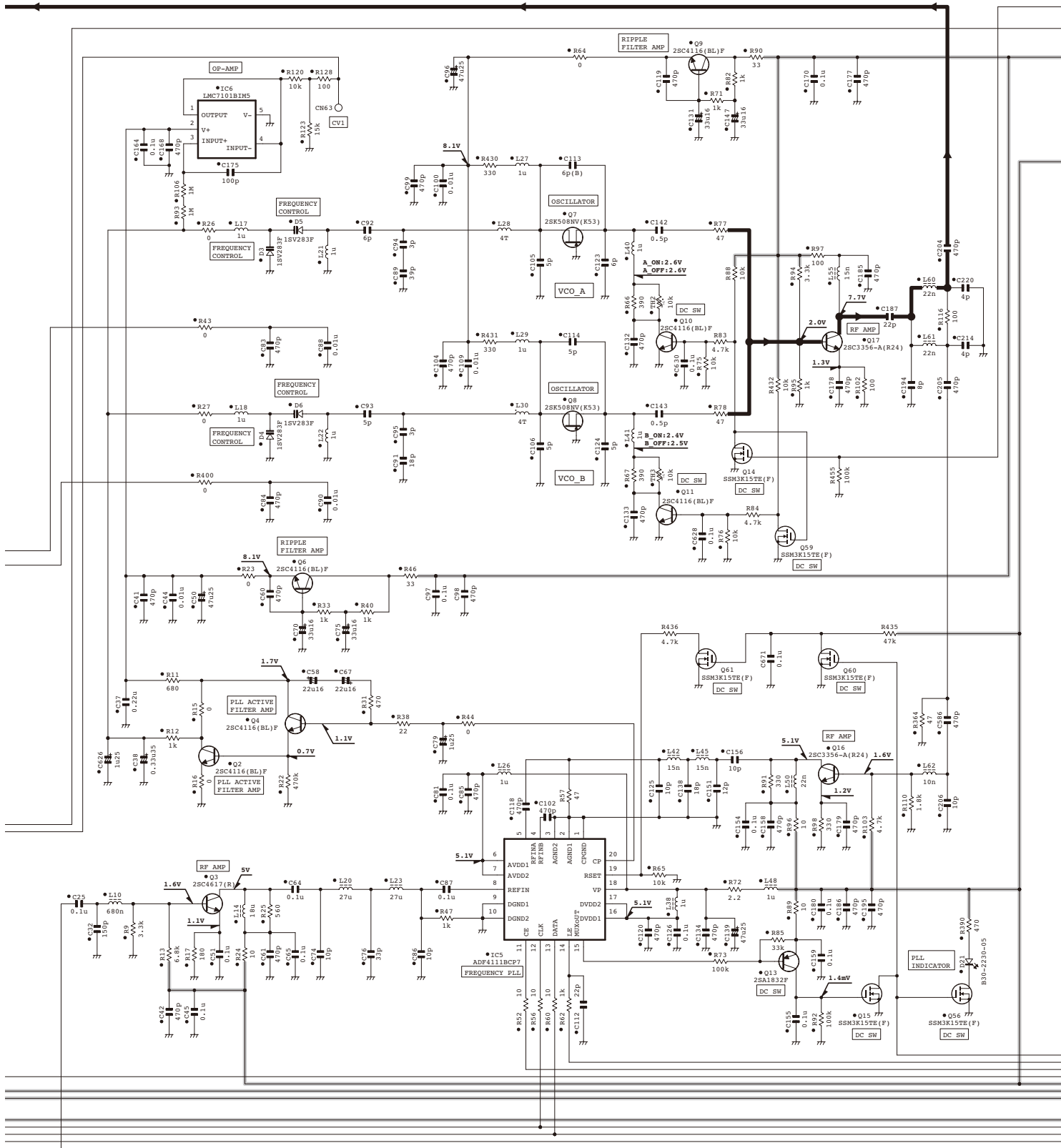

# NXR-800 SCHEMATIC DIAGRAM

RX UNIT (X55-3102-72)

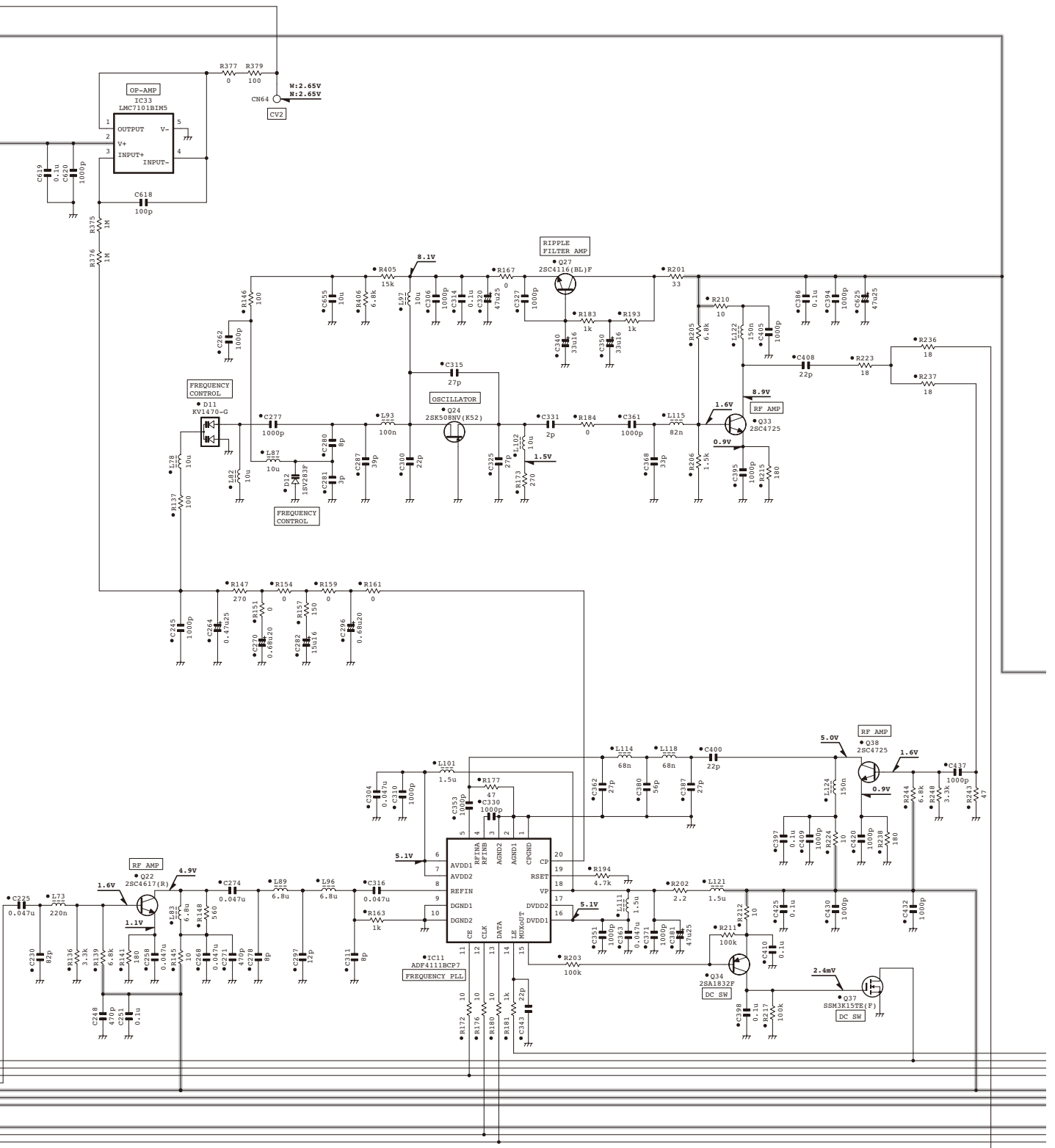

# SCHEMATIC DIAGRAM NXR-800

RX UNIT (X55-3102-72)

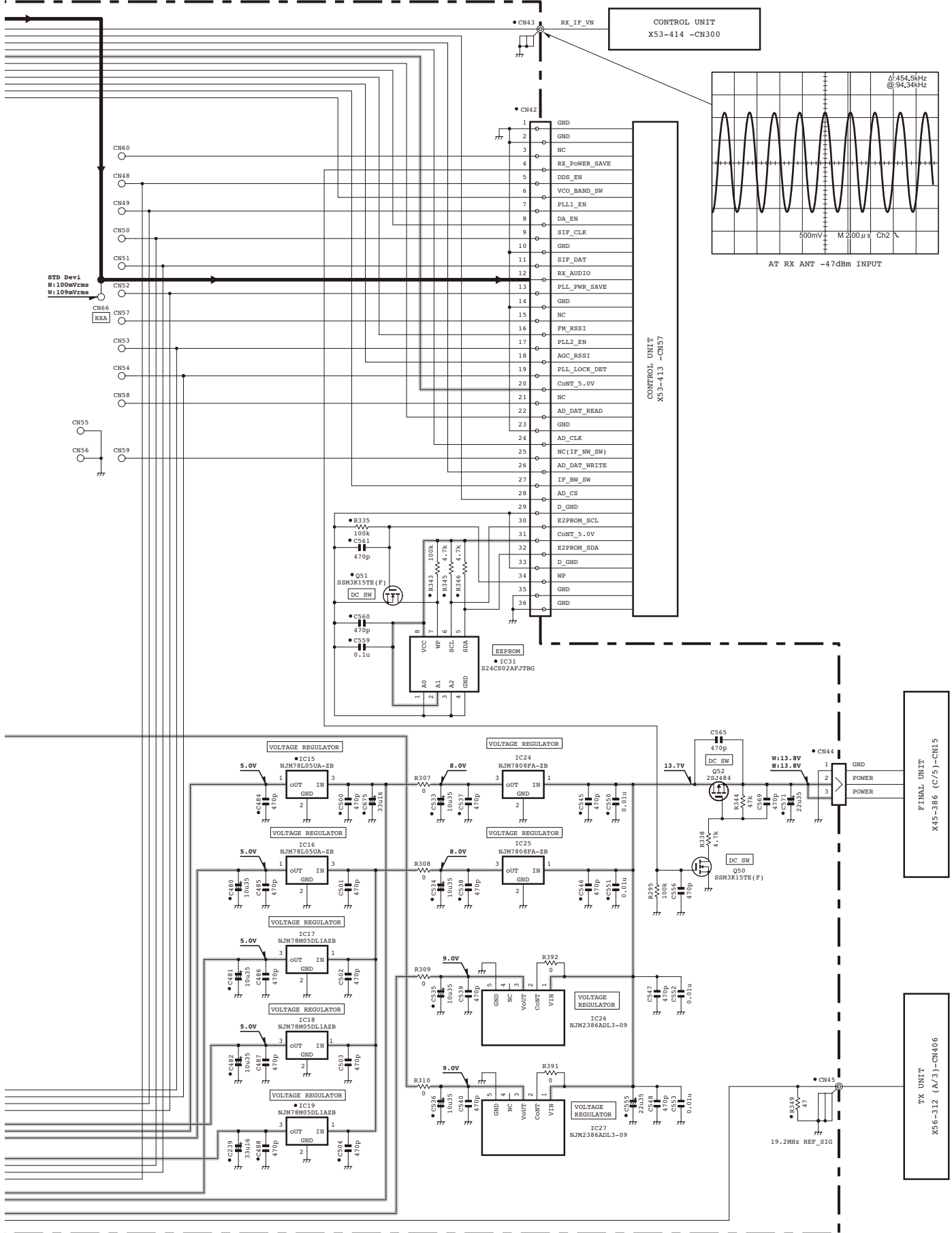

Note : The components marked with a dot (•) are parts of layer 1.

# NXR-800 SCHEMATIC DIAGRAM

TX UNIT (X56-3120-12) (A/3)

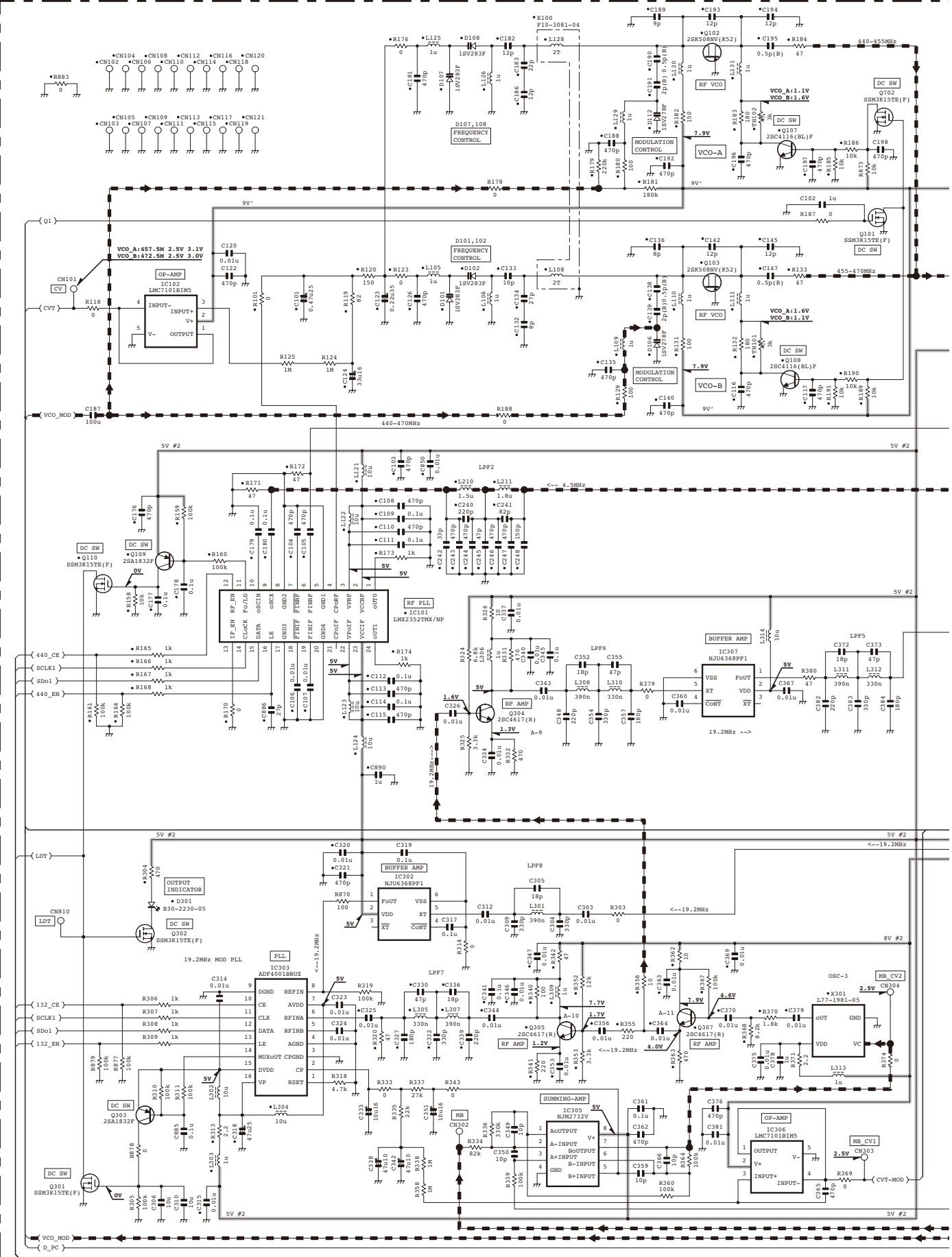

# SCHEMATIC DIAGRAM NXR-800

TX UNIT (X56-3120-12) (A/3)

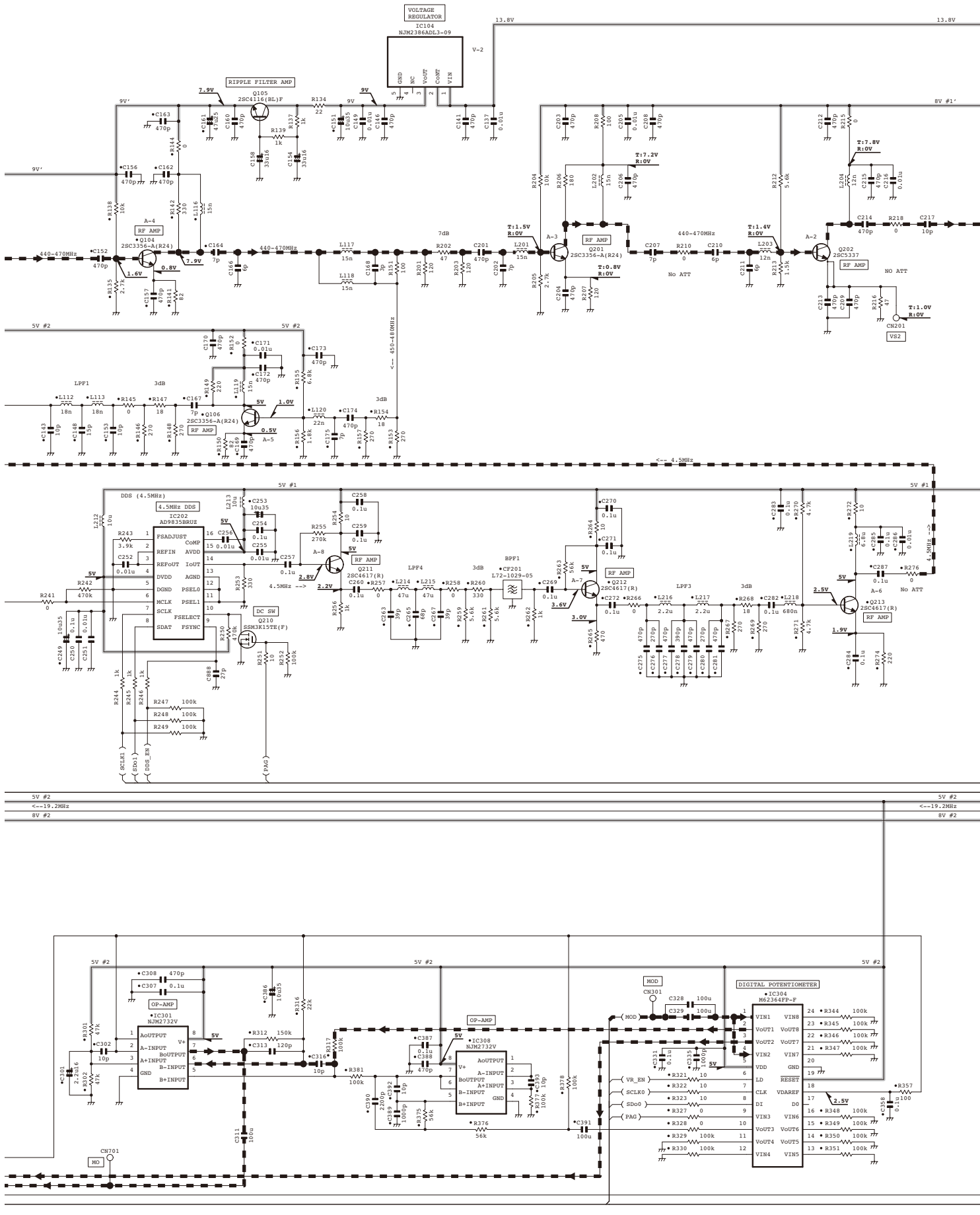

# NXR-800 SCHEMATIC DIAGRAM

TX UNIT (X56-3120-12) (A/3)

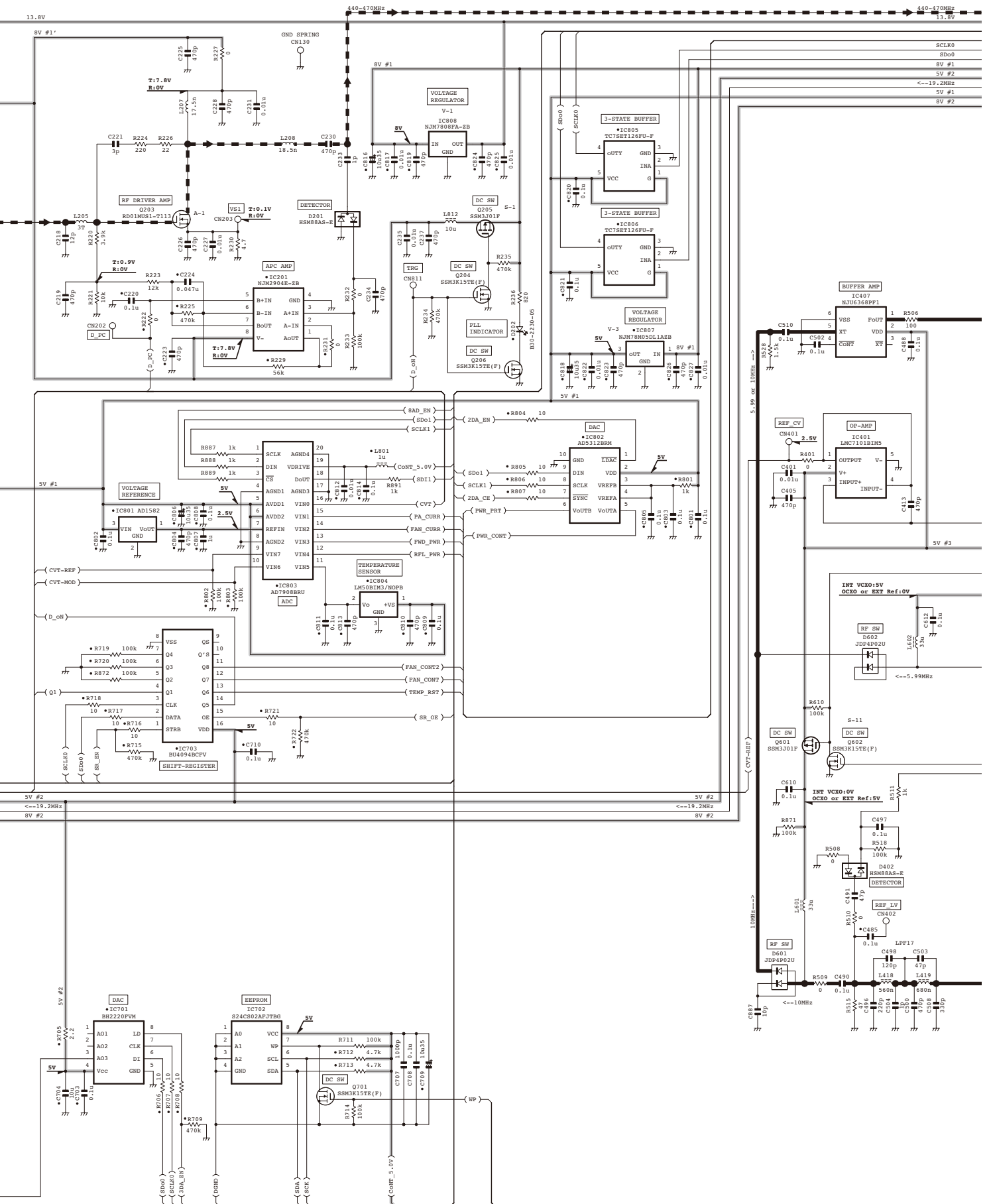

# SCHEMATIC DIAGRAM NXR-800

TX UNIT (X56-3120-12) (A/3)

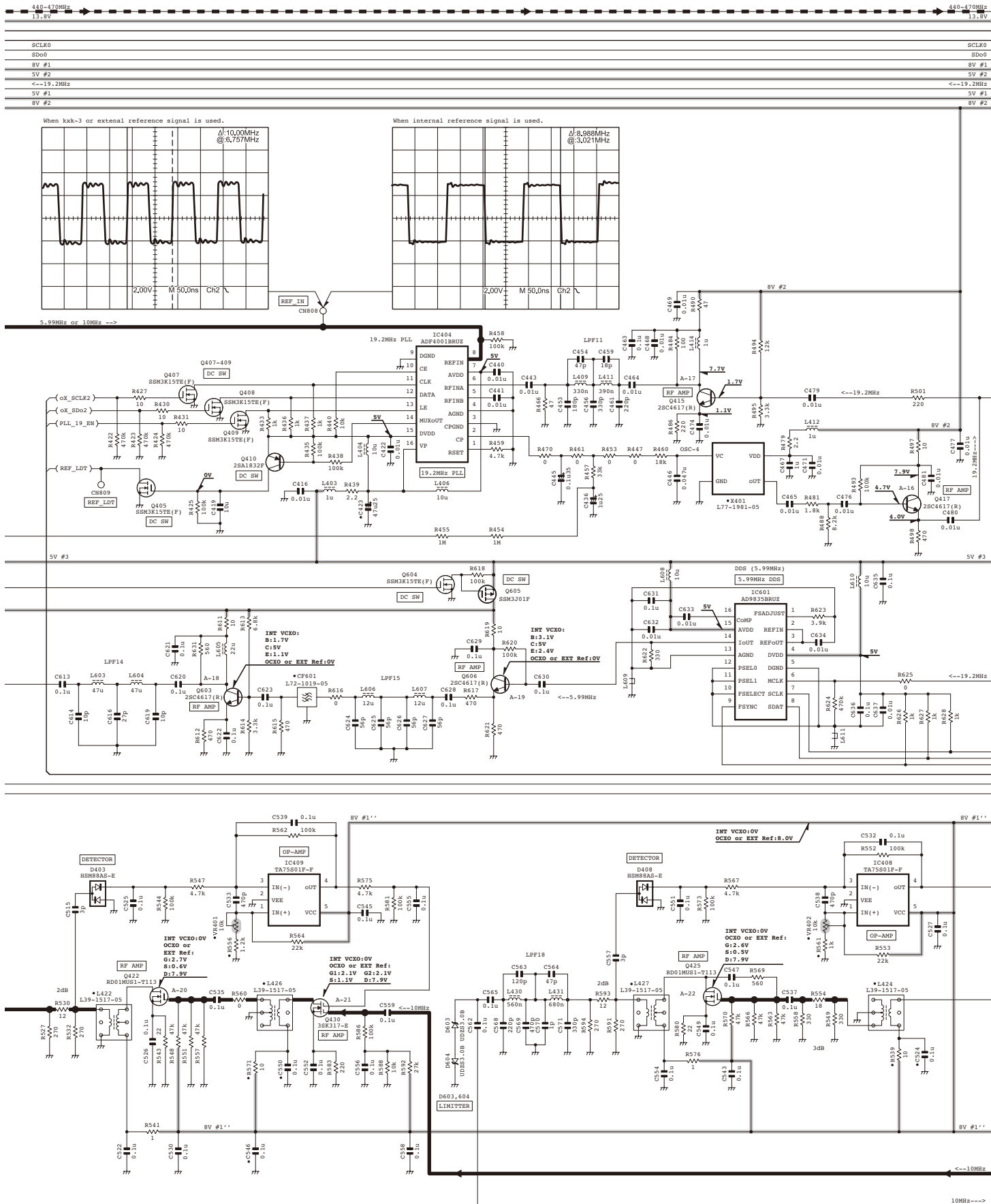

# NXR-800 SCHEMATIC DIAGRAM

TX UNIT (X56-312-12) (A/3)

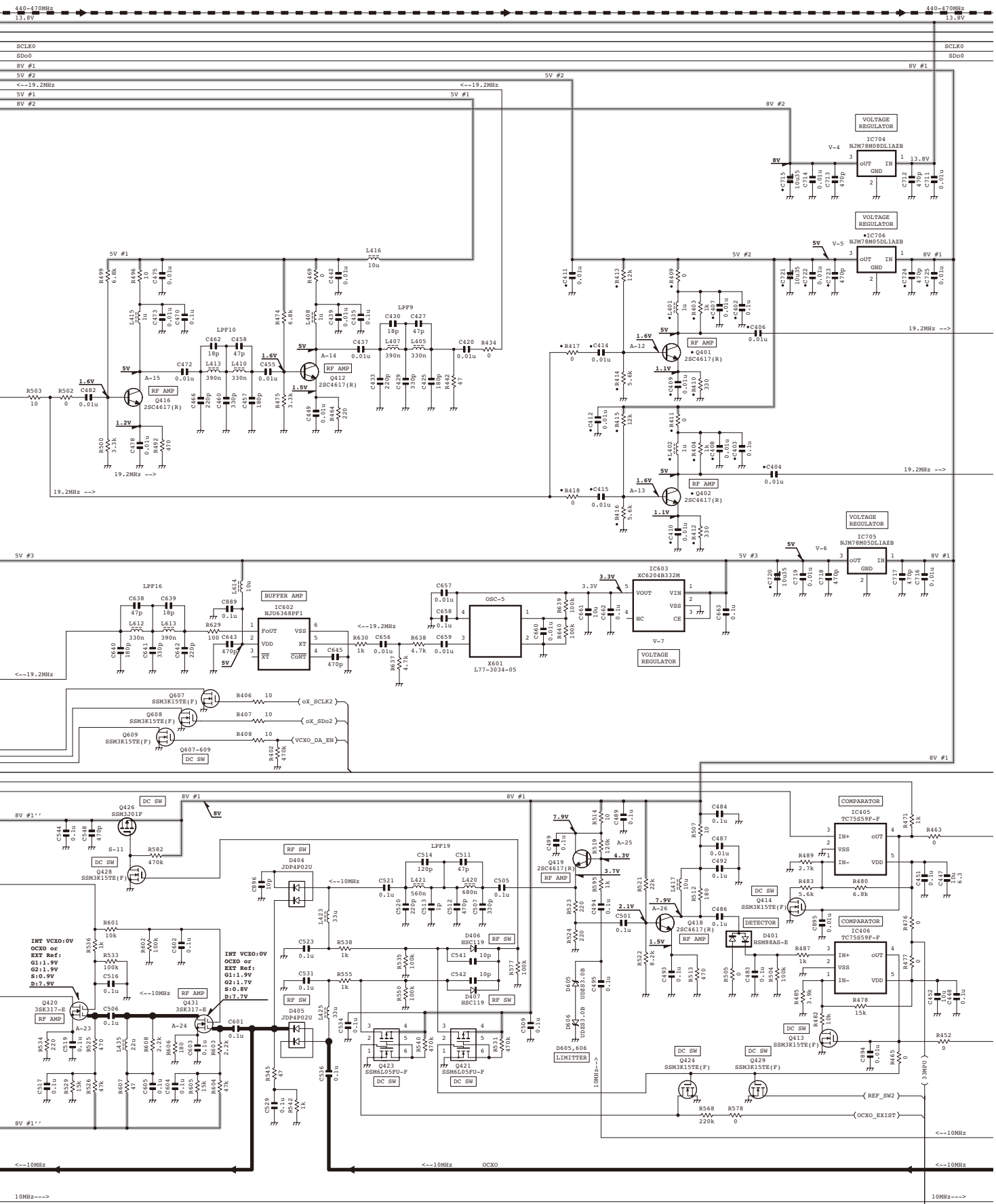



# SCHEMATIC DIAGRAM NXR-800

TX UNIT (X56-3120-12) (A/3)

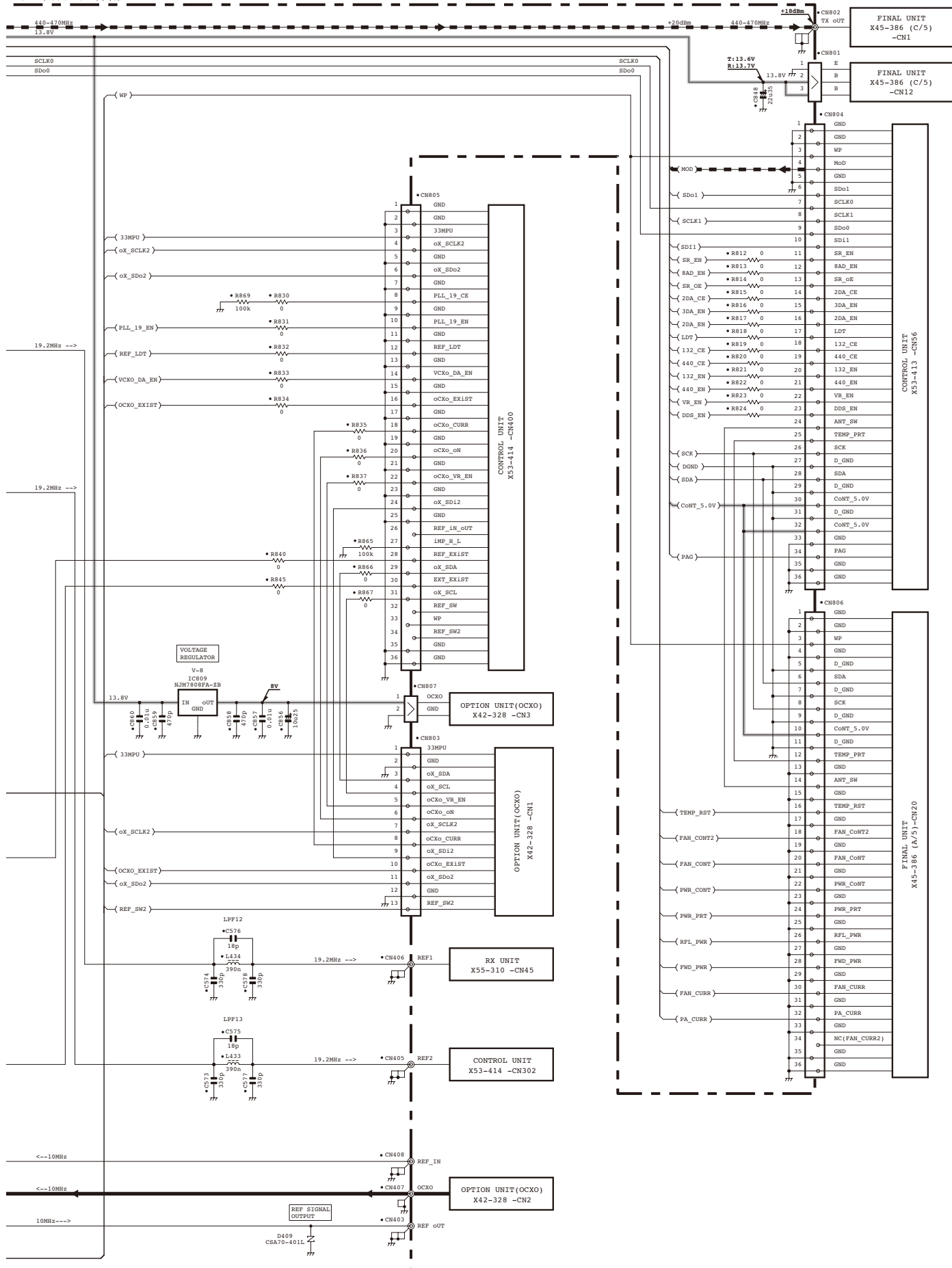

Note : The components marked with a dot (•) are parts of layer 1.

# NXR-800 SCHEMATIC DIAGRAM

TX UNIT (17SEG)  
(X56-312-12) (C/3)

TX UNIT (LED)  
(X56-3120-12) (B/3)

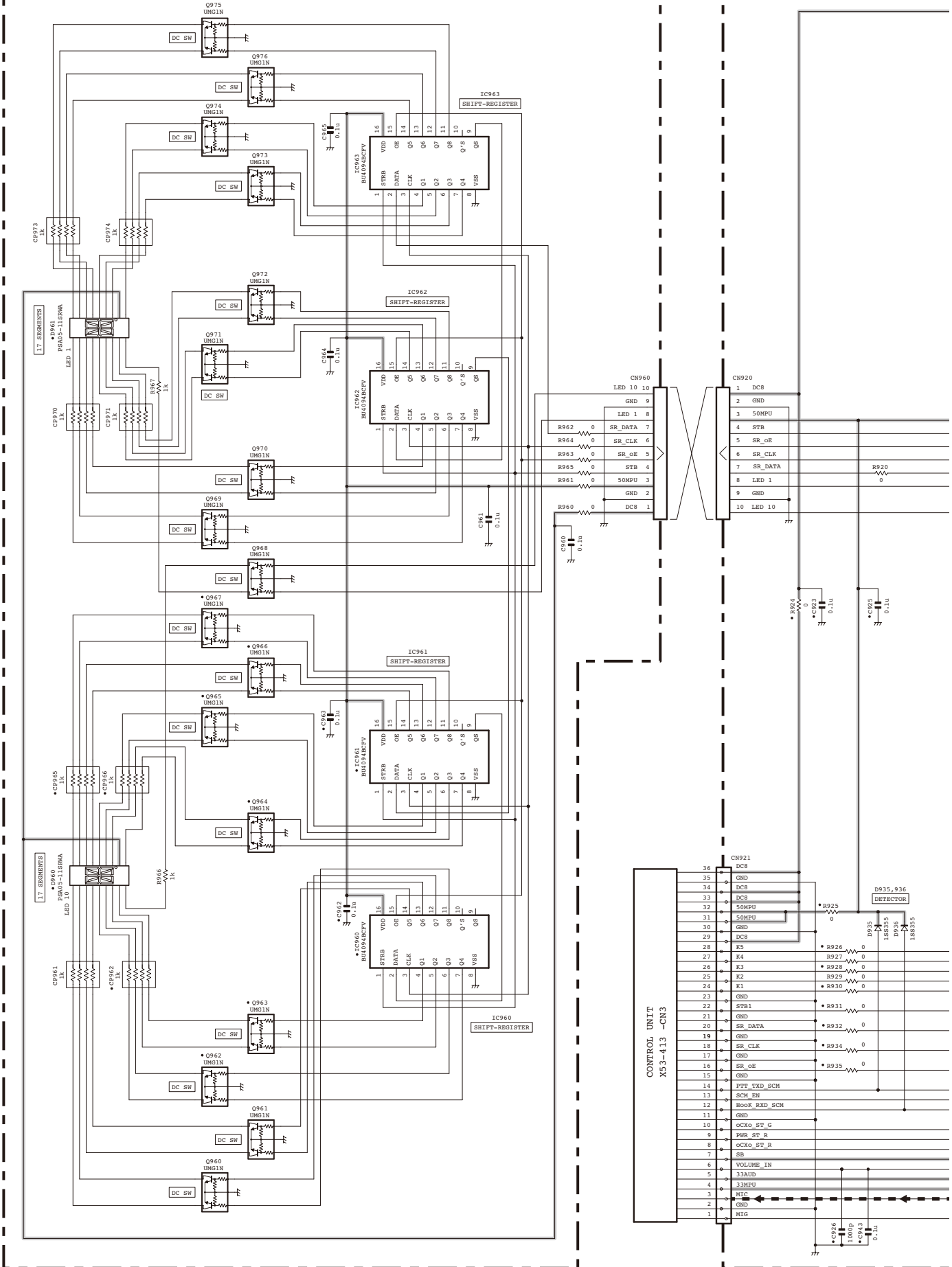

# SCHEMATIC DIAGRAM NXR-800

TX UNIT (LED)  
(X56-3120-12) (B/3)

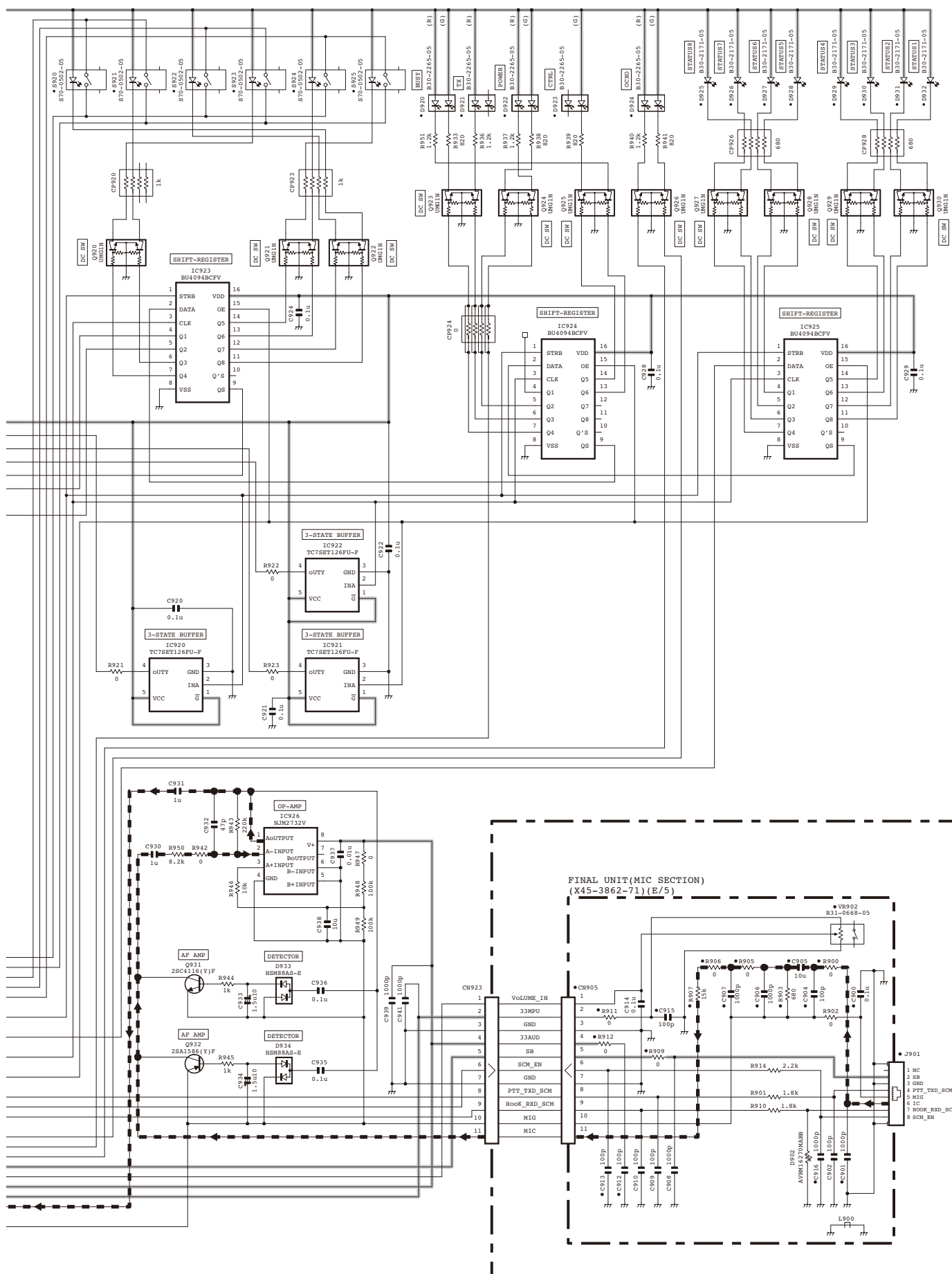

Note : The components marked with a dot (•) are parts of layer 1.

# NXR-800

## SPECIFICATIONS

### General

Frequency Range.....	400~430MHz
Channel Spacing	
Wide.....	25kHz
Narrow.....	12.5kHz
VN.....	6.25kHz
PLL Channel Step.....	3.125/ 5/ 6.25kHz
Frequency Stability.....	±1.5ppm
with OCXO unit.....	±1.0ppm
Operating Voltage.....	10.8~15.6V DC
Operating Temperature Range.....	-30°C~+60°C
Antenna Impedance.....	50Ω
Dimensions (W x H x D) (Projections not included)	
.....	483 x 44 x 331 mm
Weight.....	5kg

### Transmitter

RF Power Output.....	25~5W
Spurious Emission.....	-36dBm≤1GHz, -30dBm>1GHz
FM Hum & Noise (EIA)	
Wide.....	55dB
Narrow.....	50dB
Modulation.....	16K0F3E, 14K0F3E, 14K0F2D, 12K0F2D, 8K50F3E, 7K50F2D, 8K30F1E, 8K30F1D, 8K30F7W, 4K00F1E, 4K00F1D, 4K00F7W, 4K00F2D

### Receiver

Sensitivity	
Digital@6.25kHz (3% BER).....	0.27μV
Digital@12.5kHz (3% BER).....	0.33μV
Analog (12dB SINAD: EIA).....	0.30μV
Analog (20dB SINAD: EN).....	0dBμV (0.5μV)
Adjacent Channel Selectivity	
Analog Wide *1 (±25kHz).....	85dB
Analog Narrow *1 (±12.5kHz).....	78dB
Intermodulation	
Analog Wide (±50kHz/±100kHz).....	72dB
Analog Narrow (±50kHz/±100kHz).....	72dB
Spurious Respons Rejection (Analog).....	95dB
Audio Distortion (at 0.3W).....	Less than 2%
Audio Output (EXT. SP).....	3W/4Ω

\*1: Analog measurements made per TIA/EIA 603, EN300-086.

Without \*1: Analog measurements made per TIA/EIA 603A. KENWOOD reserves the right to change specifications without prior notice or obligation.

## Kenwood Corporation

2967-3, Ishikawa-machi, Hachioji-shi, Tokyo, 192-8525 Japan

### Kenwood U.S.A. Corporation

P.O. BOX 22745, 2201 East Dominguez Street, Long Beach, CA 90801-5745, U.S.A.

### Kenwood Electronics Canada Inc.

6070 Kestrel Road, Mississauga, Ontario, Canada L5T 1S8

### Kenwood Electronics Deutschland GmbH

Rembrücker Str. 15, 63150 Heusenstamm, Germany

### Kenwood Electronics Belgium N.V.

Leuvensesteenweg 248 J, 1800 Vilvoorde, Belgium

### Kenwood Electronics France S.A.

L'Etoile Paris Nord 2, 50 Allée des Impressionnistes, Bp 58416 Villepinte, 95944 Roissy Ch De Gaulle Cedex

### Kenwood Electronics UK Limited

KENWOOD House, Dwight Road, Watford, Herts., WD18 9EB United Kingdom

### Kenwood Electronics Europe B.V.

Amsterdamseweg 37, 1422 AC Uithoorn, The Netherlands

### Kenwood Electronics Italia S.p.A.

Via G. Sirtori, 7/9 20129 Milano, Italy

### Kenwood Ibérica, S.A.

Bolivia, 239-08020 Barcelona, Spain

### Kenwood Electronics Australia Pty. Ltd.

Talavera Business Park Building A, 4 Talavera Road, North Ryde NSW 2113 Australia

### Kenwood Electronics (Hong Kong) Ltd.

Unit 3712-3724, Level 37, Tower one Metroplaza, 223 Hing Fong Road, Kwai Fong, N.T., Hong Kong

### Kenwood Electronics Singapore Pte Ltd

1 Ang Mo Kio Street 63, Singapore 569110



# NXR-800 PC BOARD

# PC BOARD NXR-800

**FINAL UNIT (X45-3862-71)**  
**Component side view (J79-0290-19)**

**FINAL UNIT (X45-3862-71)**  
**Component side view (J79-0290-19)**

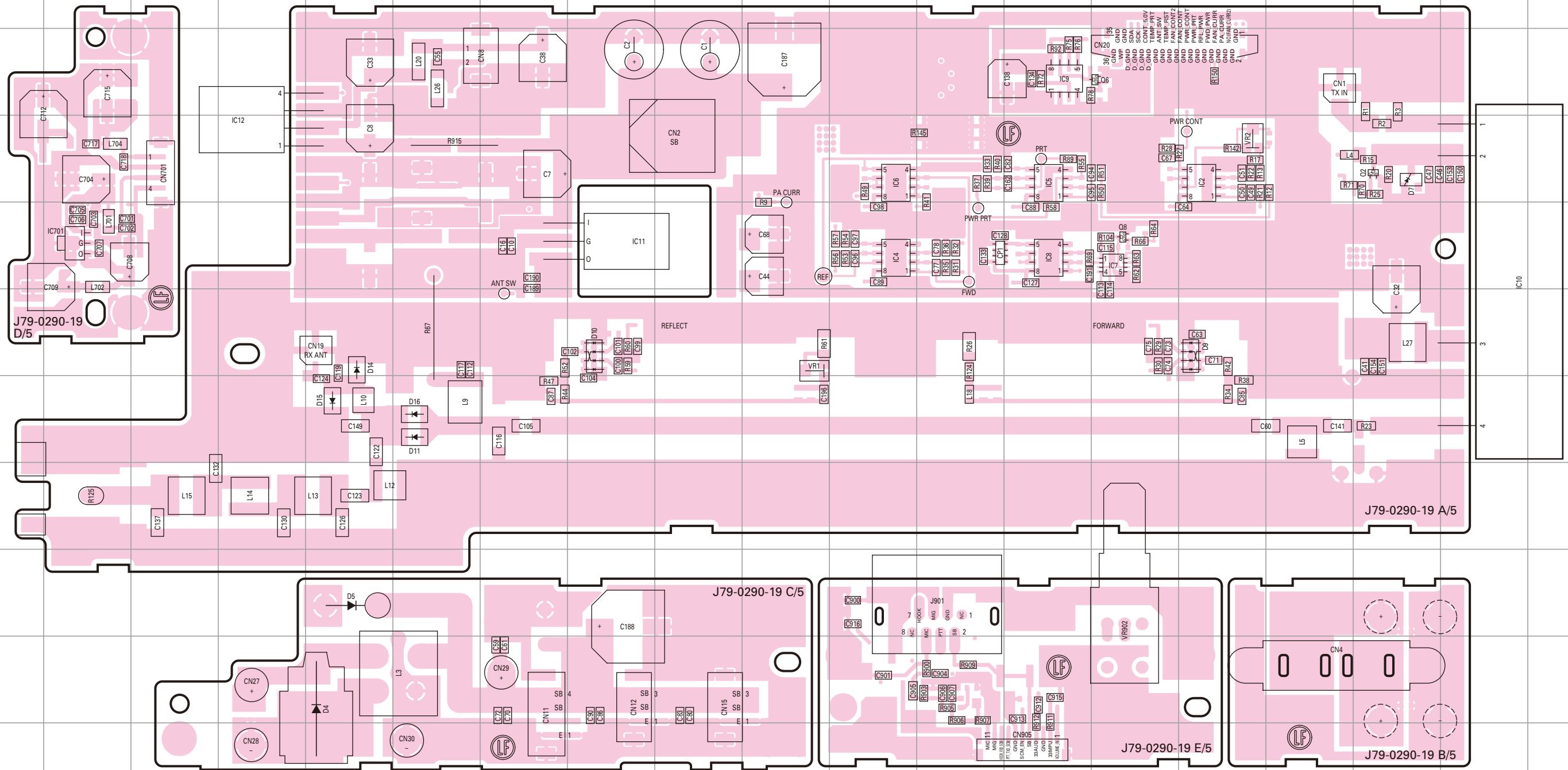

Ref. No.	Address	Ref. No.	Address	Ref. No.	Address	Ref. No.	Address	Ref. No.	Address
IC2	4O	IC8	5M	IC701	5B	D5	9E	D14	6E
IC4	5K	IC9	3M	Q2	4Q	D7	4Q	D15	7E
IC5	4M	IC10	5R	Q6	3N	D9	6O	D16	7F
IC6	4K	IC11	5H	Q8	5N	D10	6H		
IC7	5N	IC12	4D	D4	10E	D11	7F		

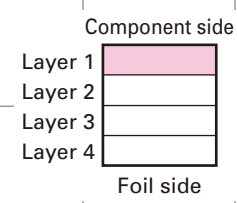

# NXR-800 PC BOARD

# PC BOARD NXR-800

FINAL UNIT (X45-3862-71)  
Foil side view (J79-0290-19)

FINAL UNIT (X45-3862-71)  
Foil side view (J79-0290-19)

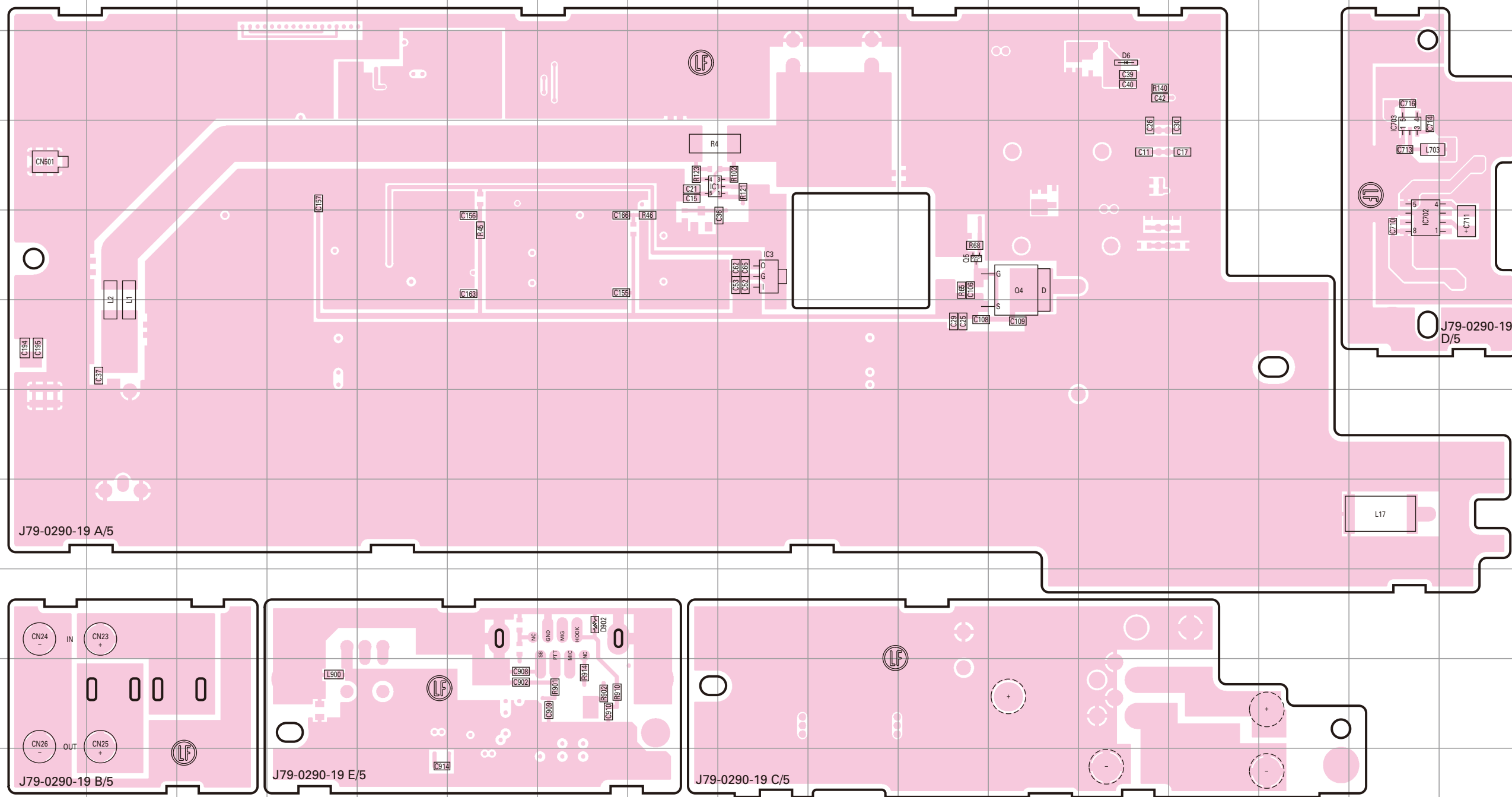

Ref. No.	Address	Ref. No.	Address
IC1	4I	Q4	5M
IC3	5J	Q5	5L
IC702	5Q	D6	3N
IC703	4Q	D902	9H

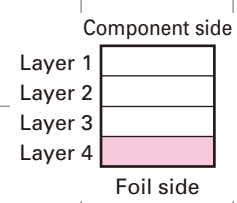

# NXR-800 PC BOARD

RX UNIT (X55-3102-72)  
Component side view (J79-0292-09)

# PC BOARD NXR-800

RX UNIT (X55-3102-72)  
Component side view (J79-0292-09)

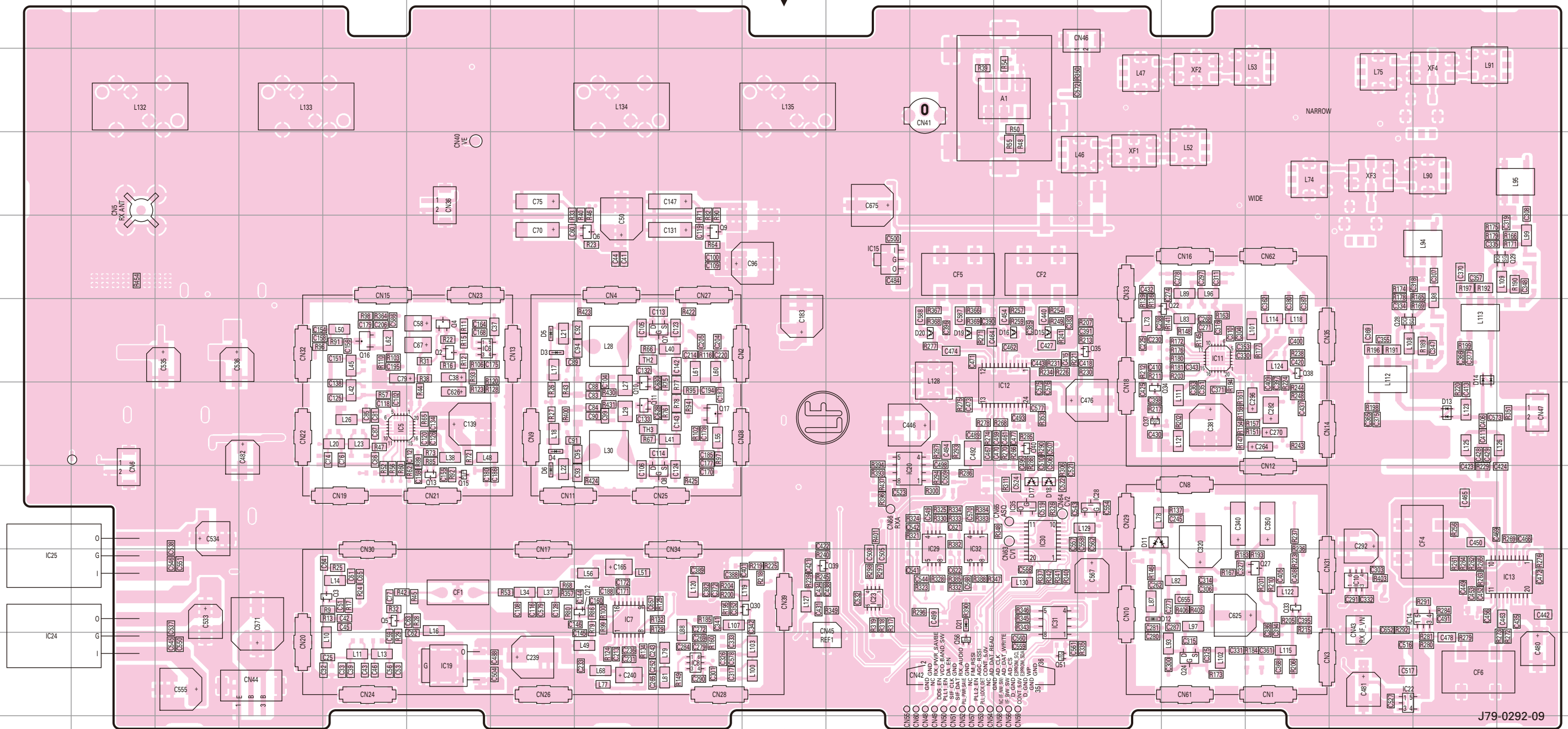

J79-0292-09

Ref. No.	Address	Ref. No.	Address	Ref. No.	Address	Ref. No.	Address	Ref. No.	Address	Ref. No.	Address	Ref. No.	Address	Ref. No.	Address
IC5	7E	IC15	5K	IC30	8M	Q7	6I	Q17	7I	Q35	6N	D5	6G	D18	8M
IC6	6F	IC19	10F	IC31	9M	Q8	8I	Q22	6O	Q37	7N	D6	8G	D19	6L
IC7	9H	IC20	8K	IC32	8L	Q9	5I	Q24	10O	Q38	6P	D11	8N	D20	6L
IC8	10I	IC22	10Q	IC35	8M	Q10	7H	Q27	9P	Q39	9J	D12	9N	D21	9L
IC10	9Q	IC23	9K	Q2	6F	Q11	7H	Q28	6Q	Q40	7M	D13	7R		
IC11	6O	IC24	10A	Q3	9E	Q12	9H	Q29	5S	Q51	10M	D14	6R		
IC12	7M	IC25	9A	Q4	6F	Q13	8F	Q30	9J	Q56	10L	D15	6M		
IC13	9S	IC28	8N	Q5	9E	Q15	8F	Q33	9P	D3	6G	D16	6M		
IC14	9R	IC29	8L	Q6	5H	Q16	6E	Q34	7N	D4	7G	D17	8M		

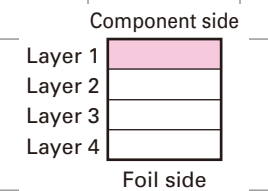



# NXR-800 PC BOARD

RX UNIT (X55-3102-72)  
Foil side view (J79-0292-09)

# PC BOARD NXR-800

RX UNIT (X55-3102-72)  
Foil side view (J79-0292-09)

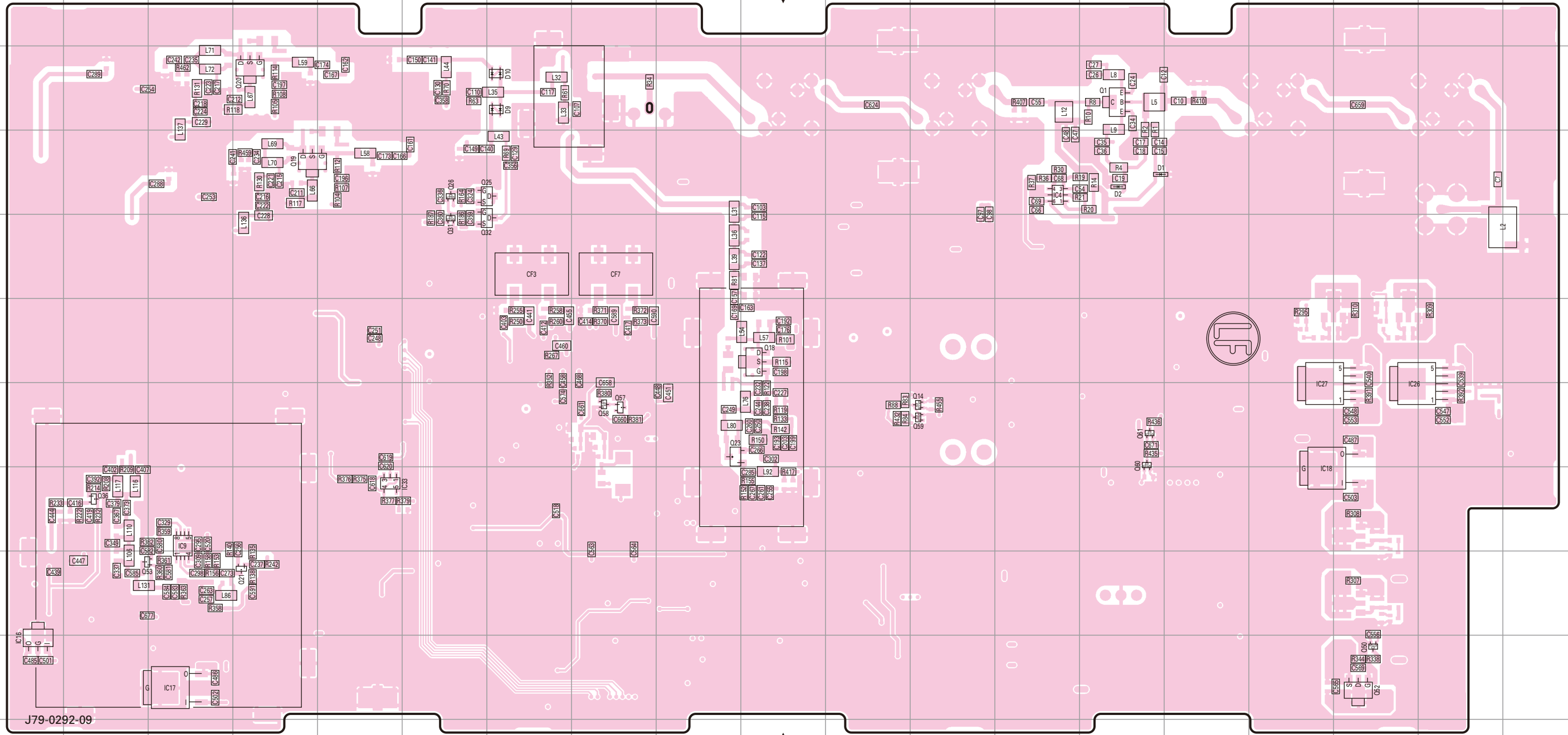

J79-0292-09

Ref. No.	Address	Ref. No.	Address	Ref. No.	Address	Ref. No.	Address
IC4	4M	Q14	7L	Q32	5G	Q61	7N
IC9	8C	Q18	6J	Q36	8B	D1	4N
IC16	10A	Q19	4D	Q50	10Q	D2	4N
IC17	10C	Q20	3D	Q52	10Q	D9	3G
IC18	8P	Q21	9D	Q53	9B	D10	3G
IC26	7Q	Q23	7I	Q57	7H		
IC27	7P	Q25	4G	Q58	7H		
IC33	8E	Q26	4F	Q59	7L		
Q1	3N	Q31	5F	Q60	7N		

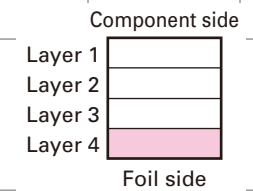



# NXR-800 PC BOARD

# PC BOARD NXR-800

**TX UNIT (X56-3120-12)**  
**Component side view (J79-0153-09)**

**TX UNIT (X56-3120-12)**  
**Component side view (J79-0153-09)**

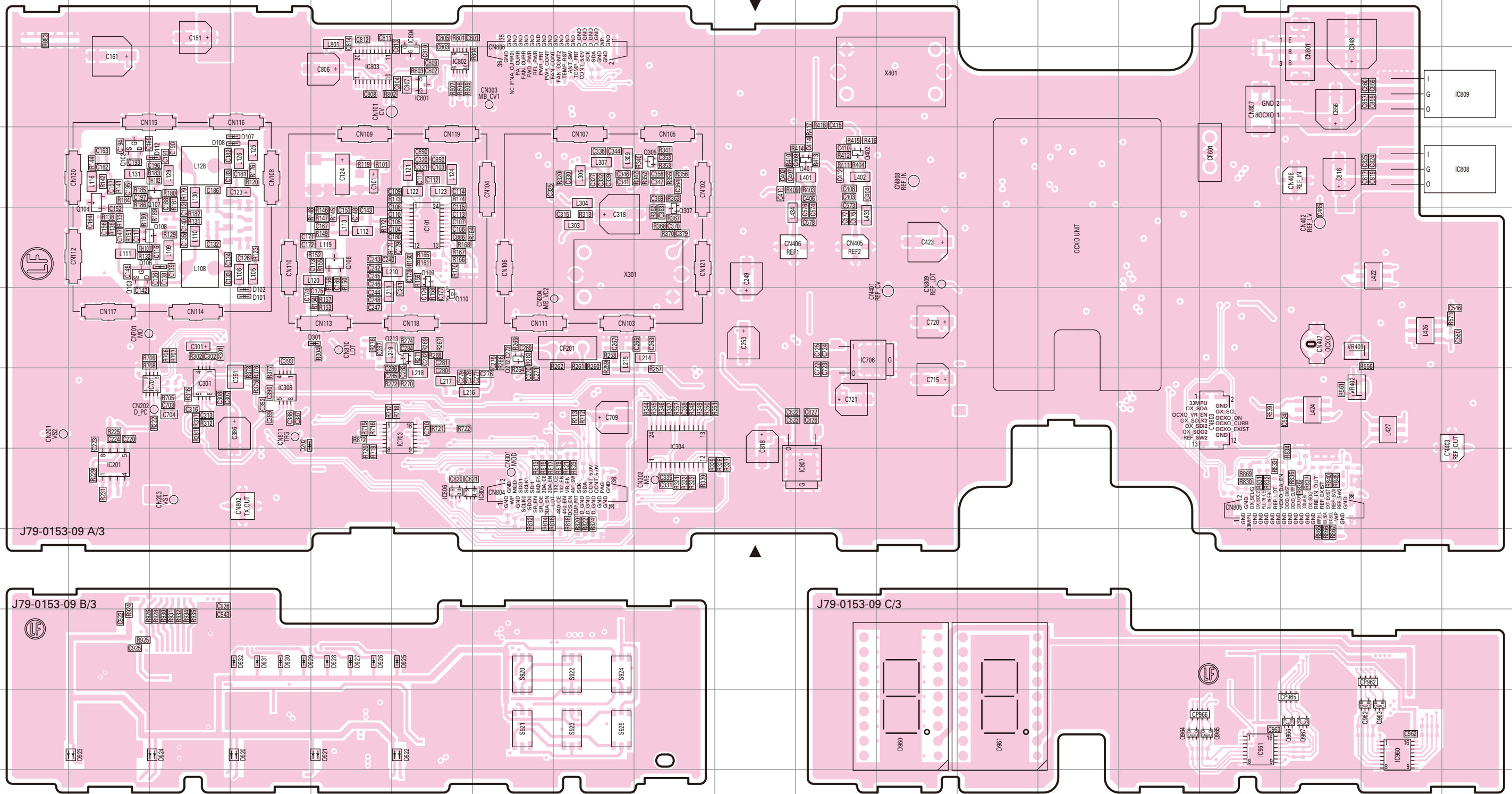

Ref. No.	Address	Ref. No.	Address	Ref. No.	Address	Ref. No.	Address	Ref. No.	Address	Ref. No.	Address	Ref. No.	Address	Ref. No.	Address
IC101	5F	IC706	6K	IC807	8K	Q104	4B	Q213	6F	Q964	11O	D107	4D	D922	11F
IC201	8B	IC801	3F	IC808	4S	Q106	5E	Q305	4I	Q965	11P	D108	4D	D923	11B
IC301	7C	IC802	3F	IC809	3S	Q107	4C	Q307	5I	Q966	11Q	D112	4C	D924	11C
IC304	7I	IC803	3E	IC900	11R	Q108	5C	Q401	4K	Q967	11Q	D202	7D	D925	10F
IC308	7D	IC804	3F	IC901	11P	Q109	5F	Q402	4K	D101	6D	D301	6E	D926	10E
IC701	7C	IC805	8F	Q102	4B	Q110	6F	Q962	11R	D102	6D	D920	11D	D927	10E
IC703	7F	IC806	8F	Q103	5B	Q212	6G	Q963	11R	D106	5C	D921	11E	D928	10E

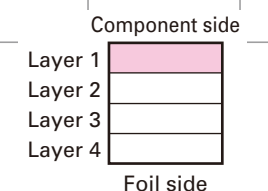

# NXR-800 PC BOARD

# PC BOARD NXR-800

**TX UNIT (X56-3120-12)**  
Foil side view (J79-0153-09)

**TX UNIT (X56-3120-12)**  
Foil side view (J79-0153-09)

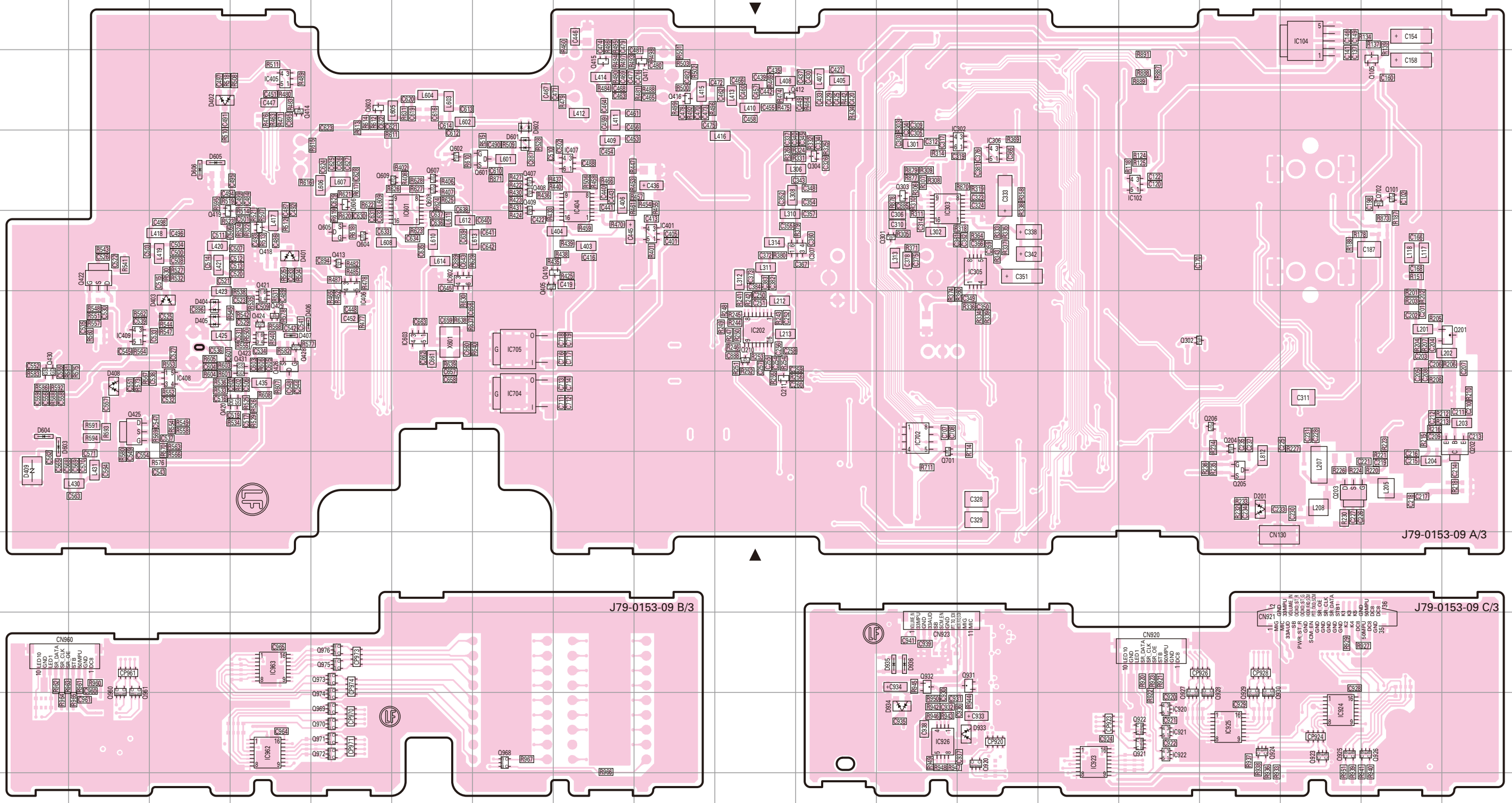

Ref. No.	Address	Ref. No.	Address	Ref. No.	Address	Ref. No.	Address	Ref. No.	Address	Ref. No.	Address	Ref. No.	Address	Ref. No.	Address	Ref. No.	Address	Ref. No.	Address	Ref. No.	Address	Ref. No.	Address	Ref. No.	Address	Ref. No.	Address	Ref. No.	Address	Ref. No.	Address	Ref. No.	Address	Ref. No.	Address	Ref. No.	Address	Ref. No.	Address	Ref. No.	Address	Ref. No.	Address														
IC102	4O	IC404	4H	IC702	7L	IC926	11L	Q205	8P	Q407	4G	Q417	3I	Q426	6D	Q605	5E	Q922	11O	Q931	10M	Q973	10E	D405	6C	D605	4C																														
IC104	2Q	IC405	3D	IC704	7G	IC962	11D	Q206	7P	Q408	4G	Q418	5D	Q428	6D	Q606	4E	Q923	11Q	Q932	10L	Q974	11E	D406	6D	D606	4C																														
IC202	6J	IC406	5E	IC705	6G	IC963	10D	Q210	6J	Q409	4G	Q419	5C	Q429	6D	Q607	4F	Q924	11P	Q960	10B	Q975	10E	D407	6D	D933	11M																														
IC302	4L	IC408	7C	IC921	11O	Q105	3R	Q301	5L	Q412	3J	Q421	6D	Q431	6D	Q609	4F	Q926	11R	Q968	11G	D201	8P	D409	8A	D935	10L																														
IC305	5M	IC409	6B	IC922	11O	Q201	6S	Q302	6O	Q413	5E	Q422	5B	Q601	4G	Q701	8L	Q927	11O	Q969	11E	D401	5D	D601	4G	D936	10L																														
IC306	4M	IC601	4F	IC923	11N	Q202	7S	Q303	4L	Q414	3D	Q423	6D	Q602	4F	Q702	4R	Q928	11P	Q970	11E	D402	3C	D602	3G																																
IC307	5K	IC602	5F	IC924	11Q	Q203	8Q	Q304	4K	Q415	3H	Q424	6D	Q603	3E	Q920	11M	Q929	11P	Q971	11E	D403	6C	D603	7A																																
IC401	5I	IC603	6F	IC925	11P	Q204	7P	Q405	5G	Q416	3I	Q425	7B	Q604	5E	Q921	11O	Q930	11P	Q972	11E	D404	6C	D604	7A																																

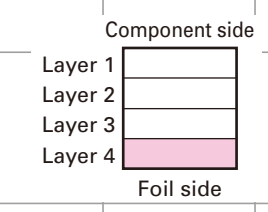

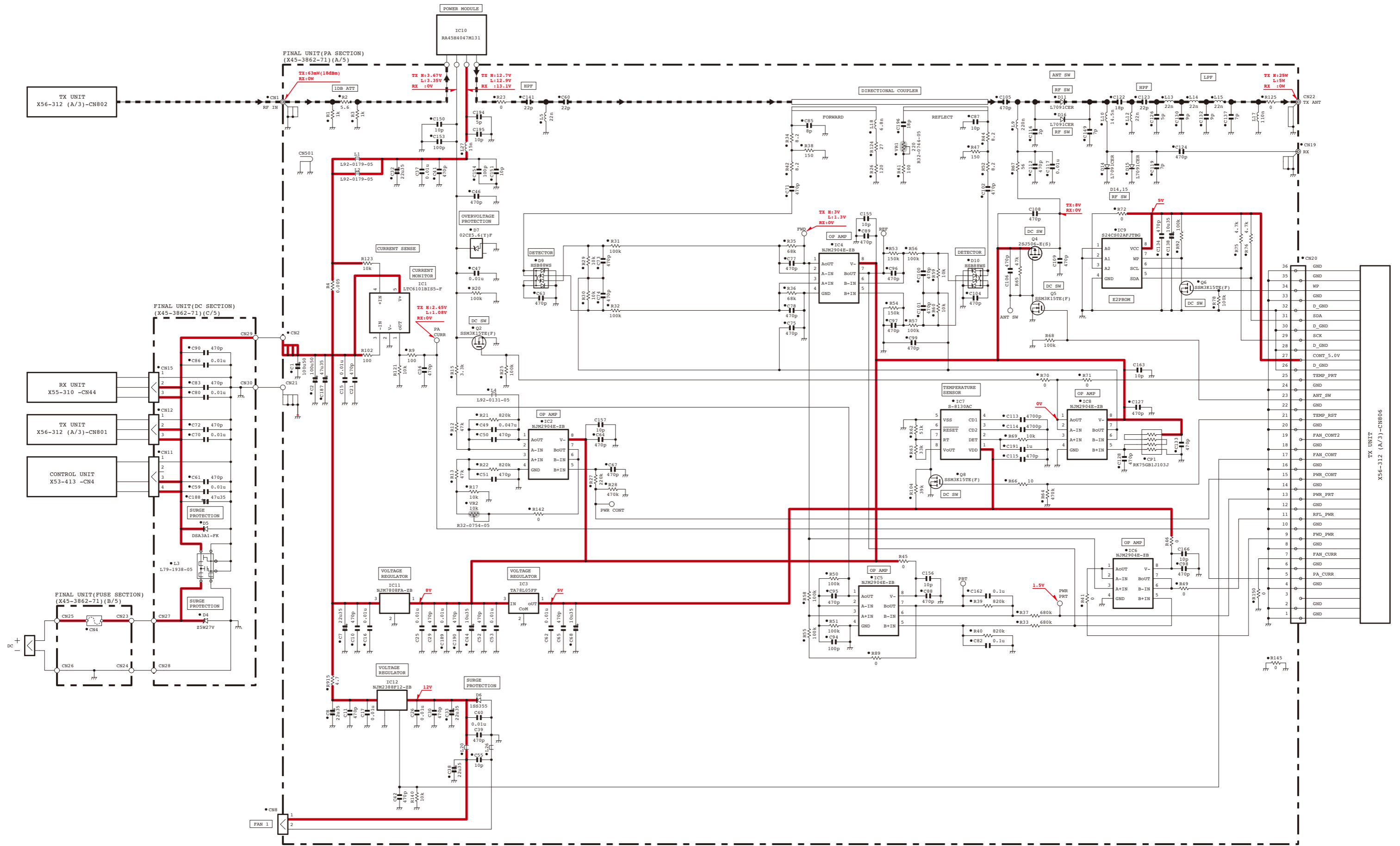



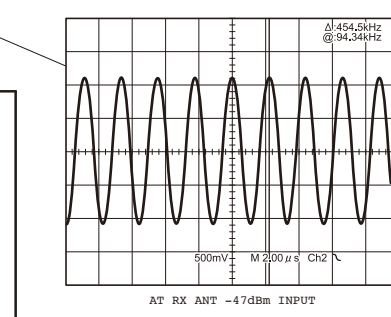
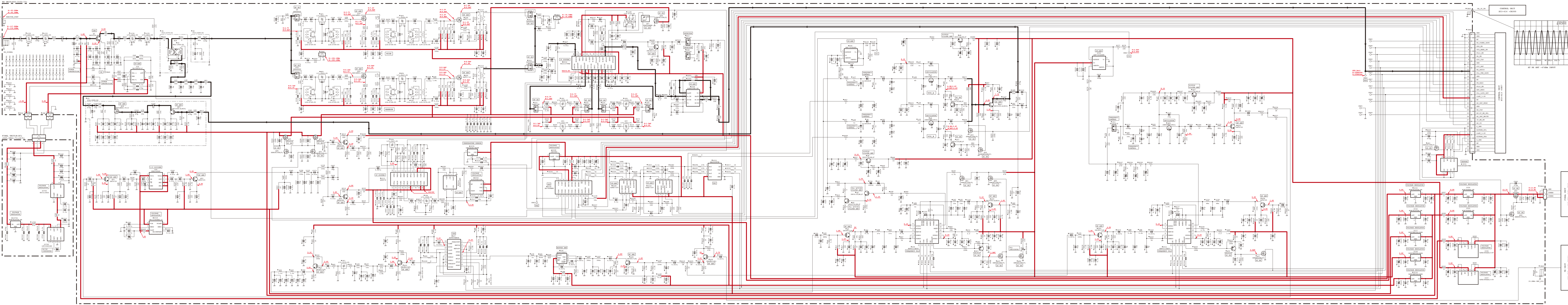

AT XE AMP - 410m INPUT

CONTROL UNIT  
X33-114 -CN309

1	0V
2	0V
3	0V
4	0V
5	0V
6	0V
7	0V
8	0V
9	0V
10	0V
11	0V
12	0V
13	0V
14	0V
15	0V
16	0V
17	0V
18	0V
19	0V
20	0V
21	0V
22	0V
23	0V
24	0V
25	0V
26	0V
27	0V
28	0V
29	0V
30	0V
31	0V
32	0V
33	0V
34	0V
35	0V
36	0V

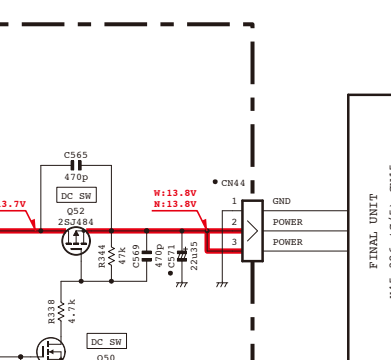

FINAL UNIT  
X33-114 -CN309

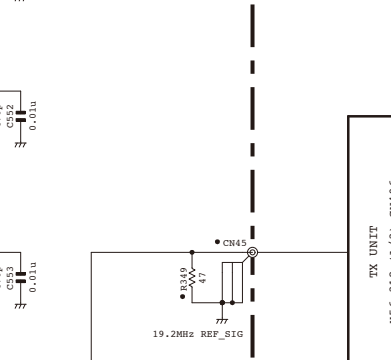

THE UNIT  
X33-114 -CN309



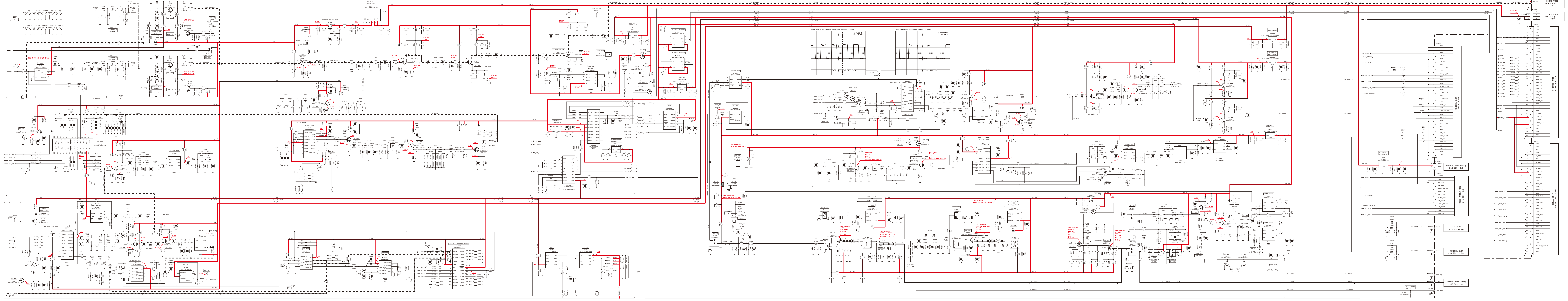

FINAL UNIT  
845-386 (C75)  
-CH1

FINAL UNIT  
845-386 (C75)  
-CH2

CONTROL UNIT  
845-386 (C75)  
-CH1

CONTROL UNIT  
845-386 (C75)  
-CH2

OPTION UNIT (OC00)  
845-310 (C845)

OPTION UNIT (OC00)  
845-310 (C845)

OPTION UNIT (OC00)  
845-310 (C845)

OPTION UNIT (OC00)  
845-310 (C845)

OPTION UNIT (OC00)  
845-310 (C845)

OPTION UNIT (OC00)  
845-310 (C845)

OPTION UNIT (OC00)  
845-310 (C845)

OPTION UNIT (OC00)  
845-310 (C845)

OPTION UNIT (OC00)  
845-310 (C845)

OPTION UNIT (OC00)  
845-310 (C845)

OPTION UNIT (OC00)  
845-310 (C845)

TX UNIT (17SEG)  
(X56-3120-12) (C/3)

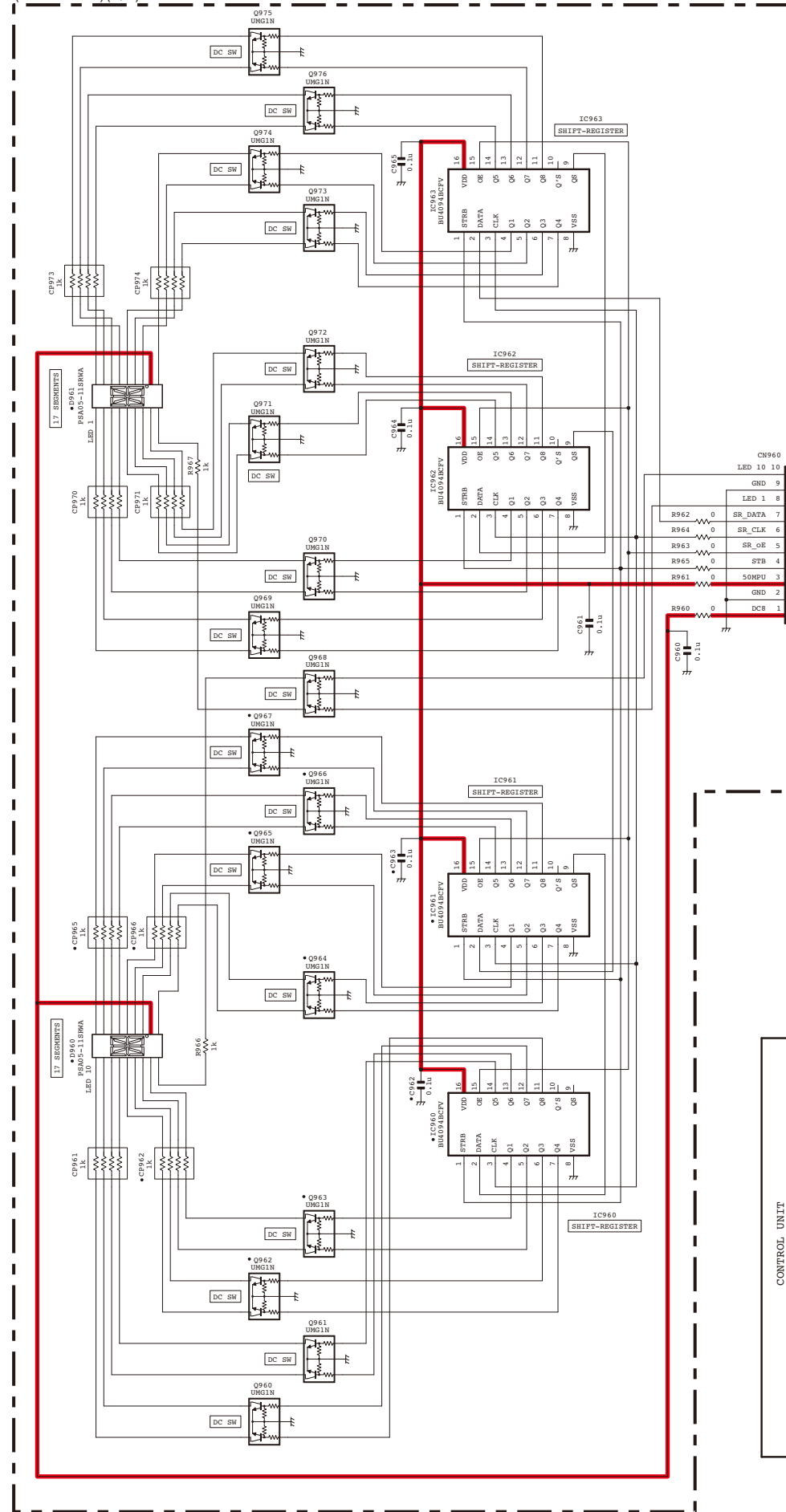

TX UNIT (LED)  
(X56-3120-12) (B/3)

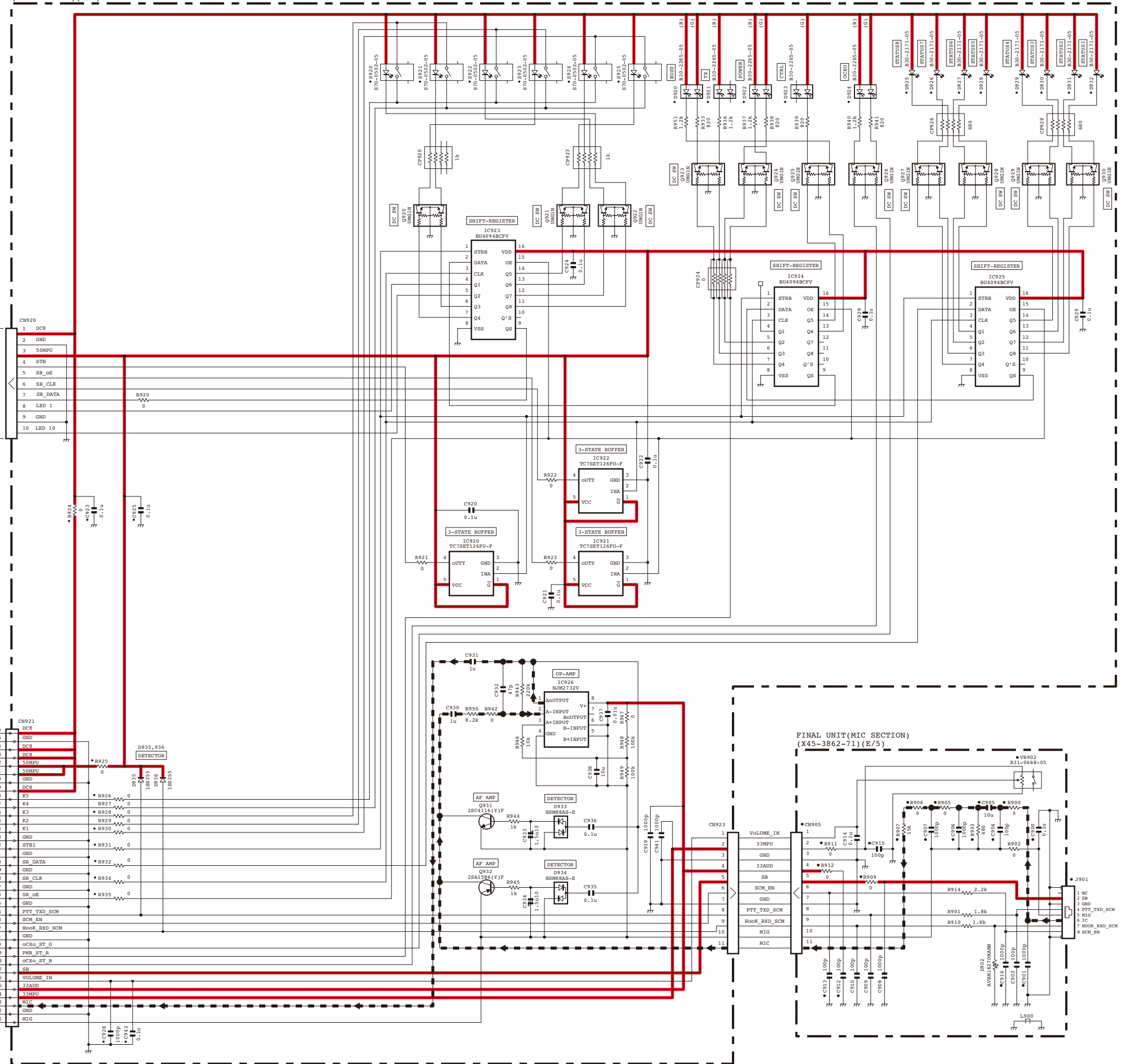

FINAL UNIT (MIC SECTION)  
(X45-3862-71) (E/5)

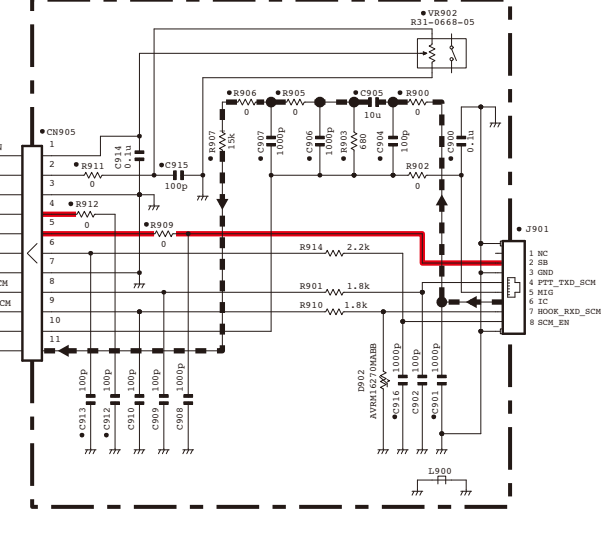



- B : N09-2292-05
- C M2 x 8 : N30-2008-43
- D M2.6 x 6 : N30-2606-48
- E M3 x 35 : N30-3035-43
- F M3 x 6 (F) : N32-3006-43
- G M4 x 8 (F) : N32-4008-43
- H : N67-3008-48
- J : N80-2006-43
- K : N80-2608-43
- L M2.6 x 8 (Br-Tap) : N87-2608-48

